

Σ-7シリーズ ACサーボドライブ Σ-7S/Σ-7W/Σ-7C サーボパック 安全上のご注意

形式 SGD7S-□□□A□□□□□□□□□□, -□□□F□□□□□□□□□□
SGD7W-□□□A□□□□□□□□□□
SGD7C-□□□A□□□□□□□□□□

製品を安全にお使い頂くために、本書を必ずお読みください。
また、本書をお手元に保管していただくとともに、最終的に本製品をご使用になるユーザー様のお手元に確実に届けられるよう、お取り計らい願います。

Σ-7-Series AC Servo Drive Σ-7S, Σ-7W, and Σ-7C SERVOPACK Safety Precautions

Model SGD7S-□□□A□□□□□□□□□□, -□□□F□□□□□□□□□□
SGD7W-□□□A□□□□□□□□□□
SGD7C-□□□A□□□□□□□□□□

To properly use the product, read this manual thoroughly and retain for easy reference, inspection, and maintenance. Ensure the end user receives this manual.

Entraînement de servomécanisme CA modèles Σ-7 SERVOPACK modèles Σ-7S, Σ-7W et Σ-7C Précautions de sécurité

Modèle SGD7S-□□□A□□□□□□□□□□, -□□□F□□□□□□□□□□
SGD7W-□□□A□□□□□□□□□□
SGD7C-□□□A□□□□□□□□□□

Pour utiliser correctement le produit, lisez attentivement ce manuel. Conservez-le comme références et pour les cas d'inspections et de maintenance. Assurez-vous que l'utilisateur final reçoive ce manuel.

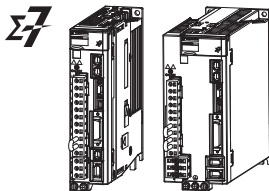

Copyright © 2014 YASKAWA ELECTRIC CORPORATION

All rights reserved. No part of this publication may be reproduced, stored in a retrieval system, or transmitted, in any form, or by any means, mechanical, electronic, photocopying, recording, or otherwise, without the prior written permission of Yaskawa. No patent liability is assumed with respect to the use of the information contained herein. Moreover, because Yaskawa is constantly striving to improve its high-quality products, the information contained in this manual is subject to change without notice. Every precaution has been taken in the preparation of this manual. Nevertheless, Yaskawa assumes no responsibility for errors or omissions. Neither is any liability assumed for damages resulting from the use of the information contained in this publication.

Safety Precautions

◆ Safety Information

To prevent personal injury and equipment damage in advance, the following signal words are used to indicate safety precautions in this document. The signal words are used to classify the hazards and the degree of damage or injury that may occur if a product is used incorrectly. Information marked as shown below is important for safety. Always read this information and heed the precautions that are provided.



DANGER

- Indicates precautions that, if not heeded, are likely to result in loss of life, serious injury, or fire.



WARNING

- Indicates precautions that, if not heeded, could result in loss of life, serious injury, or fire.



CAUTION

- Indicates precautions that, if not heeded, could result in relatively serious or minor injury, or in fire.

NOTICE

- Indicates precautions that, if not heeded, could result in property damage.

◆ Safety Precautions That Must Always Be Observed

■ General Precautions



DANGER

- Read and understand this manual to ensure the safe usage of the product.
- Keep this manual in a safe, convenient place so that it can be referred to whenever necessary. Make sure that it is delivered to the final user of the product.
- Do not remove covers, cables, connectors, or optional devices while power is being supplied to the SERVOPACK.
There is a risk of electric shock, operational failure of the product, or burning.



WARNING

- Use a power supply with specifications (number of phases, voltage, frequency, and AC/DC type) that are appropriate for the product.
There is a risk of burning, electric shock, or fire.
- Connect the ground terminals on the SERVOPACK and Servomotor to ground poles according to local electrical codes (100 Ω or less for a SERVOPACK with a 100-VAC or 200-VAC power supply, and 10 Ω or less for a SERVOPACK with a 400-VAC power supply).
There is a risk of electric shock or fire.
- Do not attempt to disassemble, repair, or modify the product.
There is a risk of fire or failure.
The warranty is void for the product if you disassemble, repair, or modify it.



CAUTION

- The SERVOPACK heat sinks, regenerative resistors, External Dynamic Brake Resistors, Servomotors, and other components can be very hot while power is ON or soon after the power is turned OFF. Implement safety measures, such as installing covers, so that hands and parts such as cables do not come into contact with hot components.
There is a risk of burn injury.
- For a 24-VDC power supply, use a power supply device with double insulation or reinforced insulation.
There is a risk of electric shock.
- Do not damage, pull on, apply excessive force to, place heavy objects on, or pinch cables.
There is a risk of failure, damage, or electric shock.
- The person who designs the system that uses the hard wire base block safety function must have a complete knowledge of the related safety standards and a complete understanding of the instructions in this document.
There is a risk of injury, product damage, or machine damage.
- Do not use the product in an environment that is subject to water, corrosive gases, or flammable gases, or near flammable materials.
There is a risk of electric shock or fire.

NOTICE

- Do not attempt to use a SERVOPACK or Servomotor that is damaged or that has missing parts.
- Install external emergency stop circuits that shut OFF the power supply and stops operation immediately when an error occurs.
- In locations with poor power supply conditions, install the necessary protective devices (such as AC reactors) to ensure that the input power is supplied within the specified voltage range.
There is a risk of damage to the SERVOPACK.
- Use a Noise Filter to minimize the effects of electromagnetic interference.
Electronic devices used near the SERVOPACK may be affected by electromagnetic interference.
- Always use a Servomotor and SERVOPACK in one of the specified combinations.
- Do not touch a SERVOPACK or Servomotor with wet hands.
There is a risk of product failure.

■ Storage Precautions



CAUTION

- Do not place an excessive load on the product during storage. (Follow all instructions on the packages.)
There is a risk of injury or damage.

NOTICE

- Do not install or store the product in any of the following locations.
 - Locations that are subject to direct sunlight
 - Locations that are subject to ambient temperatures that exceed product specifications
 - Locations that are subject to relative humidities that exceed product specifications
 - Locations that are subject to condensation as the result of extreme changes in temperature
 - Locations that are subject to corrosive or flammable gases
 - Locations that are near flammable materials
 - Locations that are subject to dust, salts, or iron powder
 - Locations that are subject to water, oil, or chemicals
 - Locations that are subject to vibration or shock that exceeds product specifications
 - Locations that are subject to radiation
- If you store or install the product in any of the above locations, the product may fail or be damaged.

■ Transportation Precautions



CAUTION

- Transport the product in a way that is suitable to the mass of the product.
- Do not use the eyebolts on a SERVOPACK or Servomotor to move the machine.
There is a risk of damage or injury.
- When you handle a SERVOPACK or Servomotor, be careful of sharp parts, such as the corners.
There is a risk of injury.
- Do not place an excessive load on the product during transportation. (Follow all instructions on the packages.)
There is a risk of injury or damage.

NOTICE

- Do not hold onto the front cover or connectors when you move a SERVOPACK.
There is a risk of the SERVOPACK falling.
- A SERVOPACK or Servomotor is a precision device. Do not drop it or subject it to strong shock.
There is a risk of failure or damage.
- Do not subject connectors to shock.
There is a risk of faulty connections or damage.
- If disinfectants or insecticides must be used to treat packing materials such as wooden frames, plywood, or pallets, the packing materials must be treated before the product is packaged, and methods other than fumigation must be used.
Example: Heat treatment, where materials are kiln-dried to a core temperature of 56°C for 30 minutes or more.
If the electronic products, which include stand-alone products and products installed in machines, are packed with fumigated wooden materials, the electrical components may be greatly damaged by the gases or fumes resulting from the fumigation process. In particular, disinfectants containing halogen, which includes chlorine, fluorine, bromine, or iodine can contribute to the erosion of the capacitors.
- Do not overtighten the eyebolts on a SERVOPACK or Servomotor.
If you use a tool to overtighten the eyebolts, the tapped holes may be damaged.

■ Installation Precautions



CAUTION

- Install the Servomotor or SERVOPACK in a way that will support the mass given in technical documents.
- Install SERVOPACKs, Servomotors, regenerative resistors, and External Dynamic Brake Resistors on nonflammable materials.
Installation directly onto or near flammable materials may result in fire.
- Provide the specified clearances between the SERVOPACK and the control panel as well as with other devices.
There is a risk of fire or failure.
- Install the SERVOPACK in the specified orientation.
There is a risk of fire or failure.
- Do not step on or place a heavy object on the product.
There is a risk of failure, damage, or injury.
- Do not allow any foreign matter to enter the SERVOPACK or Servomotor.
There is a risk of failure or fire.

NOTICE

- Do not install or store the product in any of the following locations.
 - Locations that are subject to direct sunlight
 - Locations that are subject to ambient temperatures that exceed product specifications
 - Locations that are subject to relative humidities that exceed product specifications
 - Locations that are subject to condensation as the result of extreme changes in temperature
 - Locations that are subject to corrosive or flammable gases
 - Locations that are near flammable materials
 - Locations that are subject to dust, salts, or iron powder
 - Locations that are subject to water, oil, or chemicals
 - Locations that are subject to vibration or shock that exceeds product specifications
 - Locations that are subject to radiationIf you store or install the product in any of the above locations, the product may fail or be damaged.

- Use the product in an environment that is appropriate for the product specifications.

If you use the product in an environment that exceeds product specifications, the product may fail or be damaged.
- A SERVOPACK or Servomotor is a precision device. Do not drop it or subject it to strong shock.

There is a risk of failure or damage.
- Always install a SERVOPACK in a control panel.
- Do not allow any foreign matter to enter a SERVOPACK or a Servomotor with a Cooling Fan and do not cover the outlet from the Servomotor's cooling fan.

There is a risk of failure.

■ Wiring Precautions



DANGER

- Do not change any wiring while power is being supplied.

There is a risk of electric shock or injury.



WARNING

- **Wiring and inspections must be performed only by qualified engineers.** There is a risk of electric shock or product failure.
- **Check all wiring and power supplies carefully.** Incorrect wiring or incorrect voltage application to the output circuits may cause short-circuit failures. If a short-circuit failure occurs as a result of any of these causes, the holding brake will not work. This could damage the machine or cause an accident that may result in death or injury.
- **Connect the AC and DC power supplies to the specified SERVOPACK terminals.**
 - Connect an AC power supply to the L1, L2, and L3 terminals and the L1C and L2C terminals on the SERVOPACK.
 - Connect a DC power supply to the B1/⊕ and ⊖ 2 terminals and the L1C and L2C terminals on the SERVOPACK.
 - Do not connect a DC power supply to a SERVOPACK for a 100-VAC input.There is a risk of failure or fire.
- **If you use a SERVOPACK that supports a Dynamic Brake Option, connect an External Dynamic Brake Resistor that is suitable for the machine and equipment specifications to the specified terminals.** There is a risk of unexpected operation, machine damage, burning, or injury when an emergency stop is performed.



CAUTION

- **Wait for at least six minutes after turning OFF the power supply (with a SERVOPACK for a 100-VAC input, wait for at least nine minutes) and then make sure that the CHARGE indicator is not lit before starting wiring or inspection work. Do not touch the power supply terminals while the CHARGE lamp is lit after turning OFF the power supply because high voltage may still remain in the SERVOPACK.** There is a risk of electric shock.
- **Observe the precautions and instructions for wiring and trial operation precisely as described in this document.** Failures caused by incorrect wiring or incorrect voltage application in the brake circuit may cause the SERVOPACK to fail, damage the equipment, or cause an accident resulting in death or injury.
- **Check the wiring to be sure it has been performed correctly.** Connectors and pin layouts are sometimes different for different models. Always confirm the pin layouts in technical documents for your model before operation. There is a risk of failure or malfunction.
- **Connect wires to power supply terminals and motor connection terminals securely with the specified methods and tightening torque.** Insufficient tightening may cause wires and terminal blocks to generate heat due to faulty contact, possibly resulting in fire.

Continued on next page.

CAUTION

- Use shielded twisted-pair cables or screened unshielded multi-twisted-pair cables for I/O Signal Cables and Encoder Cables.
- Observe the following precautions when wiring the SERVOPACK's main circuit terminals.
 - Turn ON the power supply to the SERVOPACK only after all wiring, including the main circuit terminals, has been completed.
 - If a connector is used for the main circuit terminals, remove the main circuit connector from the SERVOPACK before you wire it.
 - Insert only one wire per insertion hole in the main circuit terminals.
 - When you insert a wire, make sure that the conductor wire (e.g., whiskers) does not come into contact with adjacent wires.
- Install molded-case circuit breakers and other safety measures to provide protection against short circuits in external wiring.
There is a risk of fire or failure.

NOTICE

- Whenever possible, use the Cables specified by Yaskawa.
If you use any other cables, confirm the rated current and application environment of your model and use the wiring materials specified by Yaskawa or equivalent materials.
- Securely tighten cable connector screws and lock mechanisms.
Insufficient tightening may result in cable connectors falling off during operation.
- Do not bundle power lines (e.g., the Main Circuit Cable) and low-current lines (e.g., the I/O Signal Cables or Encoder Cables) together or run them through the same duct. If you do not place power lines and low-current lines in separate ducts, separate them by at least 30 cm. If the cables are too close to each other, malfunctions may occur due to noise affecting the low-current lines.
- Install a battery at either the host controller or on the Encoder Cable.
If you install batteries both at the host controller and on the Encoder Cable at the same time, you will create a loop circuit between the batteries, resulting in a risk of damage or burning.
- When connecting a battery, connect the polarity correctly.
There is a risk of battery rupture or encoder failure.

■ Operation Precautions



WARNING

- An SGD7□-□□□□□□□□□□□□□□B SERVOPACK has the specifications that were registered by the customer with the MechatroCloud service. Confirm the registered specifications before you attempt to use the SERVOPACK.
If you just turn ON the power supply to the SERVOPACK, unexpected operation may occur, and machine damage or personal injury may occur.
- **Before starting operation with a machine connected, change the settings of the switches and parameters to match the machine.**
Unexpected machine operation, failure, or personal injury may occur if operation is started before appropriate settings are made.
- **Do not radically change the settings of the parameters.**
There is a risk of unstable operation, machine damage, or injury.
- **Install limit switches or stoppers at the ends of the moving parts of the machine to prevent unexpected accidents.**
There is a risk of machine damage or injury.
- **For trial operation, securely mount the Servomotor and disconnect it from the machine.**
There is a risk of injury.
- **Forcing the motor to stop for overtravel is disabled when the Jog (Fn002), Origin Search (Fn003), or Easy FFT (Fn206) utility function is executed. Take necessary precautions.**
There is a risk of machine damage or injury.
- **When an alarm occurs, the Servomotor will coast to a stop or stop with the dynamic brake according to the SERVOPACK Option specifications and settings. The coasting distance will change with the moment of inertia of the load and the resistance of the External Dynamic Brake Resistor. Check the coasting distance during trial operation and implement suitable safety measures on the machine.**
- **Do not enter the machine's range of motion during operation.**
There is a risk of injury.
- **Do not touch the moving parts of the Servomotor or machine during operation.**
There is a risk of injury.



CAUTION

- Design the system to ensure safety even when problems, such as broken signal lines, occur.
For example, the P-OT and N-OT signals are set in the default settings to operate on the safe side if a signal line breaks. Do not change the polarity of this type of signal.
- When overtravel occurs, the power supply to the motor is turned OFF and the brake is released. If you use the Servomotor to drive a vertical load, set the Servomotor to enter a zero-clamped state after the Servomotor stops. Also, install safety devices (such as an external brake or counterweight) to prevent the moving parts of the machine from falling.
- Always turn OFF the servo before you turn OFF the power supply. If you turn OFF the main circuit power supply or control power supply during operation before you turn OFF the servo, the Servomotor will stop as follows:
 - If you turn OFF the main circuit power supply during operation without turning OFF the servo, the Servomotor will stop abruptly with the dynamic brake.
 - If you turn OFF the control power supply without turning OFF the servo, the stopping method that is used by the Servomotor depends on the model of the SERVOPACK. For details, refer to the manual for the SERVOPACK.
 - If you use a SERVOPACK that supports a Dynamic Brake Option, the Servomotor stopping methods will be different from the stopping methods used without the Option or for other Hardware Option specifications. For details, refer to the product manual for the Dynamic Brake Option.
- Do not use the dynamic brake for any application other than an emergency stop.
There is a risk of failure due to rapid deterioration of elements in the SERVOPACK and the risk of unexpected operation, machine damage, burning, or injury.

NOTICE

- When you adjust the gain during system commissioning, use a measuring instrument to monitor the torque waveform and speed waveform and confirm that there is no vibration.
If a high gain causes vibration, the Servomotor will be damaged quickly.
- Do not frequently turn the power supply ON and OFF. After you have started actual operation, allow at least one hour between turning the power supply ON and OFF (as a guideline).
Do not use the product in applications that require the power supply to be turned ON and OFF frequently.
The elements in the SERVOPACK will deteriorate quickly.

Continued on next page.

NOTICE

- An alarm or warning may occur if communications are performed with the host controller while the SigmaWin+ or Digital Operator is operating.
If an alarm or warning occurs, it may interrupt the current process and stop the system.
- After you complete trial operation of the machine and facilities, use the SigmaWin+ to back up the settings of the SERVOPACK parameters. You can use them to reset the parameters after SERVOPACK replacement.
If you do not copy backed up parameter settings, normal operation may not be possible after a faulty SERVOPACK is replaced, possibly resulting in machine or equipment damage.

■ Maintenance and Inspection Precautions



DANGER

- Do not change any wiring while power is being supplied.
There is a risk of electric shock or injury.



WARNING

- Wiring and inspections must be performed only by qualified engineers.
There is a risk of electric shock or product failure.



CAUTION

- Wait for at least six minutes after turning OFF the power supply (with a SERVOPACK for a 100-VAC input, wait for at least nine minutes) and then make sure that the CHARGE indicator is not lit before starting wiring or inspection work. Do not touch the power supply terminals while the CHARGE lamp is lit after turning OFF the power supply because high voltage may still remain in the SERVOPACK.
There is a risk of electric shock.
- Before you replace a SERVOPACK, back up the settings of the SERVOPACK parameters. Copy the backed up parameter settings to the new SERVOPACK and confirm that they were copied correctly.
If you do not copy backed up parameter settings or if the copy operation is not completed normally, normal operation may not be possible, possibly resulting in machine or equipment damage.

NOTICE

- Discharge all static electricity from your body before you operate any of the buttons or switches inside the front cover of the SERVOPACK.
There is a risk of equipment damage.

■ Troubleshooting Precautions



DANGER

- If the safety device (molded-case circuit breaker or fuse) installed in the power supply line operates, remove the cause before you supply power to the SERVOPACK again. If necessary, repair or replace the SERVOPACK, check the wiring, and remove the factor that caused the safety device to operate.

There is a risk of fire, electric shock, or injury.



WARNING

- The product may suddenly start to operate when the power supply is recovered after a momentary power interruption. Design the machine to ensure human safety when operation restarts.

There is a risk of injury.



CAUTION

- When an alarm occurs, remove the cause of the alarm and ensure safety. Then reset the alarm or turn the power supply OFF and ON again to restart operation.
There is a risk of injury or machine damage.
- If the Servo ON signal is input to the SERVOPACK and an alarm is reset, the Servomotor may suddenly restart operation. Confirm that the servo is OFF and ensure safety before you reset an alarm.
There is a risk of injury or machine damage.

- Always insert a magnetic contactor in the line between the main circuit power supply and the main circuit power supply terminals on the SERVOPACK so that the power supply can be shut OFF at the main circuit power supply.

If a magnetic contactor is not connected when the SERVOPACK fails, a large current may flow, possibly resulting in fire.

- If an alarm occurs, shut OFF the main circuit power supply.
There is a risk of fire due to a regenerative resistor overheating as the result of regenerative transistor failure.
- Install a ground fault detector against overloads and short-circuiting or install a molded-case circuit breaker combined with a ground fault detector.

There is a risk of SERVOPACK failure or fire if a ground fault occurs.

- The holding brake on a Servomotor will not ensure safety if there is the possibility that an external force (including gravity) may move the current position and create a hazardous situation when power is interrupted or an error occurs. If an external force may cause movement, install an external braking mechanism that ensures safety.

■ Disposal Precautions

- When disposing of the product, treat it as ordinary industrial waste. However, local ordinances and national laws must be observed. Implement all labeling and warnings as a final product as required.

■ General Precautions

- Figures provided in this document are typical examples or conceptual representations. There may be differences between them and actual wiring, circuits, and products.
- The products shown in illustrations in this document are sometimes shown without covers or protective guards. Always replace all covers and protective guards before you use the product.
- If you need a new copy of this document because it has been lost or damaged, contact your nearest Yaskawa representative or one of the offices listed on the back of this document.
- This document is subject to change without notice for product improvements, specifications changes, and improvements to the manual itself.
We will update the document number of the document and issue revisions when changes are made.
- Any and all quality guarantees provided by Yaskawa are null and void if the customer modifies the product in any way. Yaskawa disavows any responsibility for damages or losses that are caused by modified products.

Warranty

◆ Details of Warranty

■ Warranty Period

The warranty period for a product that was purchased (hereinafter called the “delivered product”) is one year from the time of delivery to the location specified by the customer or 18 months from the time of shipment from the Yaskawa factory, whichever is sooner.

■ Warranty Scope

Yaskawa shall replace or repair a defective product free of charge if a defect attributable to Yaskawa occurs during the above warranty period.

This warranty does not cover defects caused by the delivered product reaching the end of its service life and replacement of parts that require replacement or that have a limited service life.

This warranty does not cover failures that result from any of the following causes.

- Improper handling, abuse, or use in unsuitable conditions or in environments not described in product catalogs or manuals, or in any separately agreed-upon specifications
- Causes not attributable to the delivered product itself
- Modifications or repairs not performed by Yaskawa
- Use of the delivered product in a manner in which it was not originally intended
- Causes that were not foreseeable with the scientific and technological understanding at the time of shipment from Yaskawa
- Events for which Yaskawa is not responsible, such as natural or human-made disasters

◆ Limitations of Liability

- Yaskawa shall in no event be responsible for any damage or loss of opportunity to the customer that arises due to failure of the delivered product.
- Yaskawa shall not be responsible for any programs (including parameter settings) or the results of program execution of the programs provided by the user or by a third party for use with programmable Yaskawa products.
- The information described in product catalogs or manuals is provided for the purpose of the customer purchasing the appropriate product for the intended application. The use thereof does not guarantee that there are no infringements of intellectual property rights or other proprietary rights of Yaskawa or third parties, nor does it construe a license.
- Yaskawa shall not be responsible for any damage arising from infringements of intellectual property rights or other proprietary rights of third parties as a result of using the information described in catalogs or manuals.

◆ Suitability for Use

- It is the customer's responsibility to confirm conformity with any standards, codes, or regulations that apply if the Yaskawa product is used in combination with any other products.
- The customer must confirm that the Yaskawa product is suitable for the systems, machines, and equipment used by the customer.
- Consult with Yaskawa to determine whether use in the following applications is acceptable. If use in the application is acceptable, use the product with extra allowance in ratings and specifications, and provide safety measures to minimize hazards in the event of failure.
 - Outdoor use, use involving potential chemical contamination or electrical interference, or use in conditions or environments not described in product catalogs or manuals
 - Nuclear energy control systems, combustion systems, railroad systems, aviation systems, vehicle systems, medical equipment, amusement machines, and installations subject to separate industry or government regulations
 - Systems, machines, and equipment that may present a risk to life or property
 - Systems that require a high degree of reliability, such as systems that supply gas, water, or electricity, or systems that operate continuously 24 hours a day
 - Other systems that require a similar high degree of safety
- Never use the product for an application involving serious risk to life or property without first ensuring that the system is designed to secure the required level of safety with risk warnings and redundancy, and that the Yaskawa product is properly rated and installed.
- The circuit examples and other application examples described in product catalogs and manuals are for reference. Check the functionality and safety of the actual devices and equipment to be used before using the product.
- Read and understand all use prohibitions and precautions, and operate the Yaskawa product correctly to prevent accidental harm to third parties.

◆ Specifications Change

The names, specifications, appearance, and accessories of products in product catalogs and manuals may be changed at any time based on improvements and other reasons. The next editions of the revised catalogs or manuals will be published with updated code numbers. Consult with your Yaskawa representative to confirm the actual specifications before purchasing a product.

1 Product Confirmation

When you receive your Σ -7-Series SERVOPACK, confirm the following items.

Item	Confirmation Method
Did you receive the correct Σ -7-Series SERVOPACK?	Check the model number on the nameplate on the side of the SERVOPACK. Also, check all accessories.
Is the SERVOPACK damaged in any way?	Check the entire external appearance of the SERVOPACK for damage that might have occurred during shipping.
Are there any loose screws?	Use a screwdriver to check for any loose screws.

If you discover any problems with the above items, contact your Yaskawa representative immediately.

■ Nameplate

! WARNING

- An SGD7□-□□□□□□□□□□□□□□□□B SERVOPACK has the specifications that were registered by the customer with the MechatroCloud service. Confirm the registered specifications before you attempt to use the SERVOPACK. If you just turn ON the power supply to the SERVOPACK, unexpected operation may occur, and machine damage or personal injury may occur.

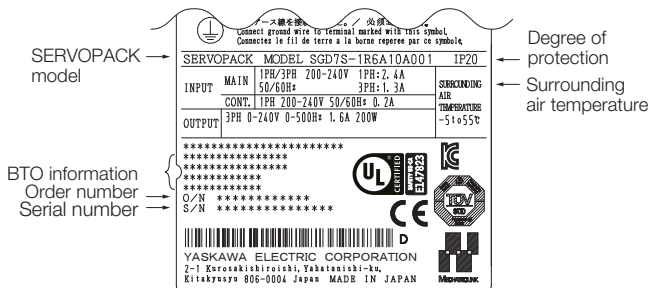

Figure 1 SERVOPACK Nameplate

■ Interpreting Manufacturing Year and Month

The manufacturing year and month are given as part of the serial number.

S/N D 0 1 4 3 H 0 9 5 6 1 0 0 0 4

3rd+4th
digits

5th digit

3rd+4th
digits

Manufacturing Year

The last two digits of the manufacturing year are given.

Example

15: 2015

16: 2016

5th digit

Manufacturing Month

The manufacturing month is given using the codes listed in the following table.

Code	Manufacturing Month
1	January
2	February
3	March
4	April
5	May
6	June
7	July
8	August
9	September
X	October
Y	November
Z	December

2 Installation

When you install a SERVOPACK, refer to *Chapter 3 SERVOPACK Installation* in the product manual for your SERVOPACK.

The installation conditions are given in the following table.

Item		Specification	
Environmental Conditions	Surrounding Air Temperature*1	Σ -7S/7W SERVOPACK -5°C to +55°C (With derating*2, usage is possible between 55°C and 60°C.)	
		Σ -7C SERVOPACK 0°C to +55°C	
	Storage Temperature	-20°C to +85°C	
	Surrounding Air Humidity	95% relative humidity max. (with no freezing or condensation)	
	Storage Humidity	95% relative humidity max. (with no freezing or condensation)	
	Vibration Resistance	4.9 m/s ²	
	Shock Resistance	19.6 m/s ²	
	Degree of Protection	Degree	SERVOPACK Models
		IP20	<ul style="list-style-type: none"> • SGD7S-R70A, -R90A, -1R6A, -2R8A, -3R8A, -5R5A, -7R6A, -120A (3-phase 200-VAC input), -R70F, -R90F, -2R1F, and -2R8F • SGD7W-1R6A, -2R8A, -5R5A, and -7R6A • SGD7C-1R6A, -2R8A, -5R5A, and -7R6A
		IP10	SGD7S-120A□□□008 (single-phase 200-VAC input), -180A, -200A, -330A, -470A, -550A, -590A, and -780A
Pollution Degree	2 <ul style="list-style-type: none"> • Must be no corrosive or flammable gases. • Must be no exposure to water, oil, or chemicals. • Must be no dust, salts, or iron powder. 		
Altitude	1,000 m max. (With derating*2, usage is possible between 1,000 m and 2,000 m.)*3		
Others	Do not use the SERVOPACK in the following locations: Locations subject to static electricity noise, strong electro-magnetic/magnetic fields, or radioactivity		

- *1. If you use a Σ -V-Series Option Module together with the SERVOPACK, the surrounding air temperature must be 0°C to 55°C. The applicable range cannot be increased by derating.
- *2. Refer to the following section for derating specifications.
 ◆ *Derating Specifications* on page 20
- *3. This does not apply if a Σ -7-Series SERVOPACK is used together with a Σ -V-Series Option Module.

Observe the following precautions when you install the SERVOPACK.

■ Installation in a Control Panel

- Design the size of the control panel, the SERVOPACK installation location, and the cooling method so that the temperature around the SERVOPACK meets the environmental conditions given on the previous page.
- If you install more than one SERVOPACK together, provide space between any two adjacent SERVOPACKs and install a fan above the SERVOPACKs. Also, provide space above and below the SERVOPACKs.

■ Installation Near Sources of Heat

Implement measures to prevent temperature increases caused by radiant or convection heat from heat sources so that the temperature around the SERVOPACK meets the environmental conditions.

■ Installation Near Sources of Vibration

Install a vibration absorber on the installation surface of the SERVOPACK so that the SERVOPACK will not be subjected to vibration.

■ Installation in Locations Subject to Corrosive Gas

Implement measures so that corrosive gas does not enter the SERVOPACK. Although corrosive gas will not immediately affect the SERVOPACK, it may cause the SERVOPACK or contact devices to fail in the future.

■ Other Precautions

- Do not install the SERVOPACK in a location subject to high temperatures, high humidity, water drops, cutting oil, excessive dust, excessive dirt, excessive iron powder, corrosive gasses, or radioactivity.
- Do not subject the SERVOPACK to freezing or condensation.
- To ensure long-term reliability, use the SERVOPACK at a surrounding air temperature of 45°C or lower.

◆ Derating Specifications

If you use the SERVOPACK at a surrounding air temperature of 55°C to 60°C or at an altitude of 1,000 m to 2,000 m, you must apply the derating rates given in the following graphs.

- Note: 1. You cannot use a Σ -7C SERVOPACK at a surrounding air temperature above 55°C even with derating.
 2. If you combine a Σ -7-Series SERVOPACK with a Σ -V-Series Option Module, you cannot exceed a surrounding air temperature of 55°C or an altitude of 1,000 m even with derating.

■ Σ -7S SERVOPACKs

- SGD7S-R70A, -R90A, -1R6A, -2R8A, -R70F, -R90F, -2R1F, and -2R8F

— (solid lines): Derating rate for all SERVOPACKs except for the SGD7S-□□□□A0A

- - - (dotted lines): Derating rate for SGD7S-□□□□A0A SERVOPACKs

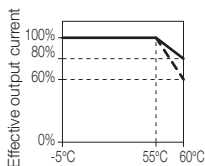

Surrounding air temperature

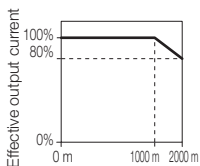

Altitude

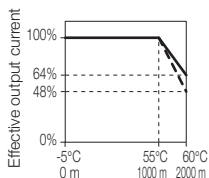

Surrounding air temperature and altitude

- SGD7S-3R8A, -5R5A, -7R6A, -120A, -180A, -200A, -330A, -470A, -550A, -590A, and -780A

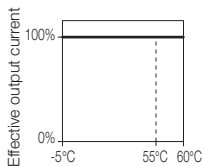

Surrounding air temperature

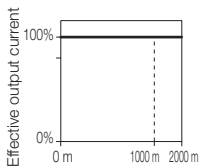

Altitude

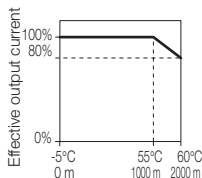

Surrounding air temperature and altitude

■ Σ -7W SERVOPACKS

- SGD7W-1R6A, -2R8A, -5R5A, and -7R6A

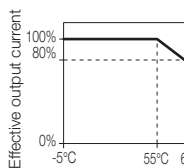

Surrounding air temperature

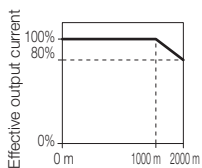

Altitude

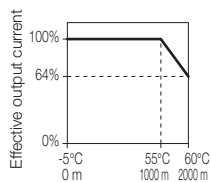

Surrounding air temperature and altitude

■ Σ -7C SERVOPACKS

- SGD7C-1R6A, -2R8A, -5R5A, and -7R6A

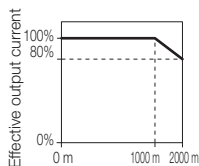

Altitude

3 Wiring

3.1 Wiring Precautions

Before you attempt to perform any wiring, read and understand the safety precautions that are given at the beginning of this document to help prevent bodily injury and equipment damage. Also observe the following precautions.

- Observe the maximum applicable voltage.
200-VAC Class: 240 Vrms AC
100-VAC Class: 120 Vrms AC
- If you use the SERVOPACK with a Linear Servomotor or similar device on a moving part, use Flexible Cables.

3.2 Terminal Symbols and Terminal Names

Use the main circuit connector and terminal block on the SERVOPACK to wire the main circuit power supply and control circuit power supply to the SERVOPACK.

The layout of the main circuit power supply terminals on the SERVOPACK and detailed SERVOPACK dimensions depend on the model of the SERVOPACK. For details, refer to the product manual for your SERVOPACK.

The SERVOPACKs have four types of main circuit power supply specifications: three-phase 200-VAC power supply input, single-phase 200-VAC power supply input, single-phase 100-VAC power supply input, and DC power supply input.

CAUTION

- Wire all connections correctly according to the following table.
If the wiring is not correct, there is a risk of SERVOPACK failure or fire.

◆ Three-Phase, 200-VAC Power Supply Input

Terminal Symbols	Terminal Name	Specification
L1, L2, and L3	Main circuit power supply input terminals for AC power supply input	Three-phase, 200 VAC to 240 VAC, -15% to +10%, 50 Hz/60 Hz

Continued on next page.

Continued from previous page.

Terminal Symbols	Terminal Name	Specification
L1C and L2C	Control power supply terminals	Single-phase, 200 VAC to 240 VAC, -15% to +10%, 50 Hz/60 Hz
B1/⊕, B2, and B3	Regenerative Resistor terminals	<ul style="list-style-type: none"> • SGD7S-R70A, -R90A, -1R6A, and -2R8A If the regenerative capacity is insufficient, connect an External Regenerative Resistor between B1/⊕ and B2. Obtain an External Regenerative Resistor separately. • SGD7S-3R8A, -5R5A, -7R6A, -120A, -180A, -200A, and -330A; SGD7W-1R6A, -2R8A, -5R5A, and -7R6A; SGD7C-1R6A, -2R8A, -5R5A, and -7R6A If the regenerative capacity is insufficient, remove the lead or short bar between B2 and B3 and connect an External Regenerative Resistor between B1/⊕ and B2. Obtain an External Regenerative Resistor separately. • SGD7S-470A, -550A, -590A, and -780A Connect a Regenerative Resistor Unit between B1/⊕ and B2. Obtain a Regenerative Resistor Unit separately. These models do not have a B3 terminal.
⊖1 and ⊖2	DC Reactor terminals for power supply harmonic suppression	These terminals are to connect a DC reactor for power supply harmonic suppression and power factor improvement.
⊖	–	None. (Do not connect anything to this terminal.) Note: The SGD7S-330A to -780A SERVOPACKs do not have a ⊖ terminal.
U, V, and W	Servomotor terminals	These are the Σ-7S connection terminals for the Servomotor Main Circuit Cable (power line).

Continued on next page.

Continued from previous page.

Terminal Symbols	Terminal Name	Specification
UA, VA, and WA	Servomotor terminals for axis A	These are the Σ -7W/ Σ -7C connection terminals for the Servomotor Main Circuit Cable (power line).
UB, VB, and WB	Servomotor terminals for axis B	
D1 and D2	Dynamic Brake Resistor terminals	These terminals are provided only on SERVOPACKs that support the Dynamic Brake Option. These terminals are used to connect an External Dynamic Brake Resistor for a Σ -7S SERVOPACK. Obtain an External Dynamic Brake Resistor separately. Note: The SGD7S-R70A to -2R8A SERVOPACKs do not have D1 and D2 terminals.
D1A and D2A	Dynamic Brake Resistor terminals for axis A	These terminals are provided only on SERVOPACKs that support the Dynamic Brake Option. These terminals are used to connect an External Dynamic Brake Resistor for a Σ -7W/ Σ -7C SERVOPACK. Obtain an External Dynamic Brake Resistor separately. Note: The SGD7W-1R6A and -2R8A and SGD7C-1R6A and -2R8A SERVOPACKs do not have D1A, D2A, D1B, and D2B terminals.
D1B and D2B	Dynamic Brake Resistor terminals for axis B	
	Ground terminal	This is the ground terminal to prevent electric shock. Always connect this terminal.

◆ Single-Phase, 200-VAC Power Supply Input

Terminal Symbols	Terminal Name	Specification
L1 and L2	Main circuit power supply input terminals for AC power supply input	Single-phase, 200 VAC to 240 VAC, -15% to +10%, 50 Hz/60 Hz
L1C and L2C	Control power supply terminals	Single-phase, 200 VAC to 240 VAC, -15% to +10%, 50 Hz/60 Hz

Continued on next page.

Continued from previous page.

Terminal Symbols	Terminal Name	Specification
B1/⊕, B2, and B3	Regenerative Resistor terminals	<ul style="list-style-type: none"> • SGD7S-R70A, -R90A, -1R6A, and -2R8A If the regenerative capacity is insufficient, connect an External Regenerative Resistor between B1/⊕ and B2. Obtain an External Regenerative Resistor separately. • SGD7S-5R5A and -120A□□□008; SGD7W-1R6A, -2R8A, and -5R5A; SGD7C-1R6A, -2R8A, and -5R5A If the regenerative capacity is insufficient, remove the lead or short bar between B2 and B3 and connect an External Regenerative Resistor between B1/⊕ and B2. Obtain an External Regenerative Resistor separately.
⊖1 and ⊖2	DC Reactor terminals for power supply harmonic suppression	These terminals are to connect a DC reactor for power supply harmonic suppression and power factor improvement.
L3 and ⊖	–	None. (Do not connect anything to this terminal.)
U, V, and W	Servomotor terminals	These are the Σ-7S connection terminals for the Servomotor Main Circuit Cable (power line).
UA, VA, and WA	Servomotor terminals for axis A	These are the Σ-7W/Σ-7C connection terminals for the Servomotor Main Circuit Cable (power line).
UB, VB, and WB	Servomotor terminals for axis B	
D1 and D2	Dynamic Brake Resistor terminals	These terminals are provided only on SERVOPACKs that support the Dynamic Brake Option. These terminals are used to connect an External Dynamic Brake Resistor for a Σ-7S SERVOPACK. Obtain an External Dynamic Brake Resistor separately. Note: The SGD7S-R70A to -2R8A SERVOPACKs do not have D1 and D2 terminals.

Continued on next page.

Continued from previous page.

Terminal Symbols	Terminal Name	Specification
D1A and D2A	Dynamic Brake Resistor terminals for axis A	These terminals are provided only on SERVOPACKs that support the Dynamic Brake Option. These terminals are used to connect an External Dynamic Brake Resistor for a Σ -7W/ Σ -7C SERVOPACK. Obtain an External Dynamic Brake Resistor separately. Note: The SGD7W-1R6A and -2R8A and SGD7C-1R6A and -2R8A SERVOPACKs do not have D1A, D2A, D1B, and D2B terminals.
D1B and D2B	Dynamic Brake Resistor terminals for axis B	
	Ground terminal	This is the ground terminal to prevent electric shock. Always connect this terminal.

The following models support a single-phase, 200-VAC power supply input.

- SGD7S-R70A, -R90A, -1R6A, -2R8A, and -5R5A
- SGD7W-1R6A, -2R8A, and -5R5A
- SGD7C-1R6A, -2R8A, and -5R5A

If you use a single-phase, 200-VAC power supply input for the SERVO-PACK's main circuit power supply, set parameter Pn00B to n.□1□□ (Single-phase power supply input supported).

◆ Single-Phase, 100-VAC Power Supply Input

Terminal Symbols	Terminal Name	Specification
L1 and L2	Main circuit power supply input terminals for AC power supply input	Single-phase, 100 VAC to 120 VAC, -15% to +10%, 50 Hz/60 Hz
L1C and L2C	Control power supply terminals	Single-phase, 100 VAC to 120 VAC, -15% to +10%, 50 Hz/60 Hz
B1 and B2	Regenerative Resistor terminals	If the regenerative capacity is insufficient, connect an External Regenerative Resistor between B1 and B2. Obtain an External Regenerative Resistor separately.
U, V, and W	Servomotor terminals	These are the connection terminals for the Servomotor Main Circuit Cable (power line).

Continued on next page.

Continued from previous page.

Terminal Symbols	Terminal Name	Specification
	Ground terminal	This is the ground terminal to prevent electric shock. Always connect this terminal.

◆ DC Power Supply Input

WARNING

- Always specify a DC power supply input (Pn001 = n.□1□□) before you input DC power for the main circuit power supply. If you input DC power without specifying a DC power supply input (i.e., without setting Pn001 to n.□1□□), the SERVOPACK's internal elements may burn and may cause fire or damage to the equipment.
- With a DC power supply input, time is required to discharge electricity after the main power supply is turned OFF. A high residual voltage may remain in the SERVOPACK after the power supply is turned OFF. Be careful not to get an electric shock. Refer to the following section for details.
 -  11 Capacitor Discharge Time on page 71
- The Servomotor returns regenerative energy to the power supply. If you use a SERVOPACK with a DC power supply input, regenerative energy is not processed. Process the regenerative energy at the power supply.
- If you use a DC power supply input with any of the following SERVOPACKs, externally connect an inrush current limiting circuit and use the power ON and OFF sequences recommended by Yaskawa: SGD7S-330A, -470A, -550A, -590A, or -780A.

There is a risk of equipment damage.
For information on the power ON and OFF sequences, refer to the product manual for your SERVOPACK.
- The SGD7S-□□□F cannot be used with a DC power supply input. Absolutely never input a DC power supply. The SERVOPACK's internal elements may burn and may cause fire or damage to the equipment.

Terminal Symbols	Terminal Name	Specification
L1C and L2C	Control power supply terminals	270 VDC to 324 VDC, -15% to +10%
B1/⊕	Main circuit power supply input terminals for DC power supply input	270 VDC to 324 VDC, -15% to +10%
⊖2		0 VDC

Continued on next page.

Continued from previous page.

Terminal Symbols	Terminal Name	Specification
L1, L2, L3, B2, B3, \ominus 1, and \ominus	–	None. (Do not connect anything to this terminal.) Note: 1. The SGD7S-470A to -780A do not have a B3 terminal. 2. The SGD7S-330A to -780A do not have a \ominus terminal.
U, V, and W	Servomotor terminals	These are the Σ -7S connection terminals for the Servomotor Main Circuit Cable (power line).
UA, VA, and WA	Servomotor terminals for axis A	These are the Σ -7W/ Σ -7C connection terminals for the Servomotor Main Circuit Cable (power line).
UB, VB, and WB	Servomotor terminals for axis B	
D1 and D2	Dynamic Brake Resistor terminals	These terminals are provided only on SERVOPACKs that support the Dynamic Brake Option. These terminals are used to connect an External Dynamic Brake Resistor for a Σ -7S SERVOPACK. Obtain an External Dynamic Brake Resistor separately. Note: The SGD7S-R70A to -2R8A SERVOPACKs do not have D1 and D2 terminals.
D1A and D2A	Dynamic Brake Resistor terminals for axis A	These terminals are provided only on SERVOPACKs that support the Dynamic Brake Option. These terminals are used to connect an External Dynamic Brake Resistor for a Σ -7W/ Σ -7C SERVOPACK. Obtain an External Dynamic Brake Resistor separately.
D1B and D2B	Dynamic Brake Resistor terminals for axis B	Note: The SGD7W-1R6A and -2R8A and SGD7C-1R6A and -2R8A SERVOPACKs do not have D1A, D2A, D1B, and D2B terminals.
	Ground terminal	This is the ground terminal to prevent electric shock. Always connect this terminal.

3.3 Molded-Case Circuit Breakers and Fuses

Using an AC Power Supply

Use a molded-case circuit breaker and fuse to protect the power supply line. They protect the power line by shutting OFF the circuit when overcurrent is detected. Select these devices based on the information in the following tables.

Note: The following tables provide the net values of the current capacity and inrush current. Select a fuse and a molded-case circuit breaker that meet the following conditions.

- Main circuit and control circuit: No breaking at three times the current value given in the table for 5 s.
- Inrush current: No breaking at the current value given in the table for 20 ms.

◆ Σ-7S SERVOPACKs

Main Circuit Power Supply	Maximum Applicable Motor Capacity [kW]	SERVO-PACK Model: SGD7S-	Power Supply Capacity per SERVO-PACK [kVA]*	Current Capacity		Inrush Current		Rated Voltage	
				Main Circuit [Arms]*	Control Power Supply [Arms]	Main Circuit [A0-p]	Control Power Supply [A0-p]	Fuse [V]	MCCB [V]
Three-phase, 200 VAC	0.05	R70A	0.2	0.4	0.2	34	34	250	240
	0.1	R90A	0.3	0.8					
	0.2	1R6A	0.5	1.3					
	0.4	2R8A	1.0	2.5					
	0.5	3R8A	1.3	3.0					
	0.75	5R5A	1.6	4.1					
	1.0	7R6A	2.3	5.7	0.25	68	250	240	
	1.5	120A	3.2	7.3					
	2.0	180A	4.0	10					
	3.0	200A	5.9	15	0.3	114	250	240	
	5.0	330A	7.5	25					
	6.0	470A	10.7	29					
	7.5	550A	14.6	37					
	11	590A	21.7	54					
15	780A	29.6	73	0.4	114	250	240		

Continued on next page.

Continued from previous page.

Main Circuit Power Supply	Maximum Applicable Motor Capacity [kW]	SERVO-PACK Model: SGD7S-	Power Supply Capacity per SERVO-PACK [kVA]*	Current Capacity		Inrush Current		Rated Voltage	
				Main Circuit [Arms]*	Control Power Supply [Arms]	Main Circuit [A0-p]	Control Power Supply [A0-p]	Fuse [V]	MCCB [V]
Single-phase, 200 VAC	0.05	R70A	0.2	0.8	0.2	34	34	250	240
	0.1	R90A	0.3	1.6					
	0.2	1R6A	0.6	2.4					
	0.4	2R8A	1.2	5.0					
	0.75	5R5A	1.9	8.7	0.25				
	1.5	120A□ □□008	4.0	16					
Single-phase, 100 VAC	0.05	R70F	0.2	1.5	0.38	34	34	250	240
	0.1	R90F	0.3	2.5					
	0.2	2R1F	0.6	5					
	0.4	2R8F	1.4	10					

* This is the net value at the rated load.

◆ Σ-7W/Σ-7C SERVOPACKs

Main Circuit Power Supply	Maximum Applicable Motor Capacity per Axis [kW]	SERVO-PACK Model: SGD7W- or SGD7C-	Power Supply Capacity per SERVO-PACK [kVA] ^{*1}	Current Capacity		Inrush Current		Rated Voltage	
				Main Circuit [Arms] ^{*1}	Control Power Supply [Arms]	Main Circuit [A0-p]	Control Power Supply [A0-p]	Fuse [V]	MCCB [V]
Three-phase, 200 VAC	0.2	1R6A	1.0	2.5	0.25	34	34	250	240
	0.4	2R8A	1.9	4.7					
	0.75	5R5A	3.2	7.8					
	1.0	7R6A	4.5	11					
Single-phase, 200 VAC	0.2	1R6A	1.3	5.5					
	0.4	2R8A	2.4	11					
	0.75	5R5A ^{*2}	2.7	12					

*1. This is the net value at the rated load.

*2. If you use the SGD7W-5R5A or SGD7C-5R5A with a single-phase 200-VAC power supply input, derate the load ratio to 65%. An example is given below.

If the load ratio of the first axis is 90%, use a load ratio of 40% for the second axis so that average load ratio for both axes is 65%.
 $((90\% + 40\%)/2 = 65\%)$

Using a DC Power Supply

This section gives the power supply specifications for using a DC power supply input. Use the Fuses given in the following tables to protect the power supply line and SERVOPACK. They protect the power line by shutting OFF the circuit when overcurrent is detected.

Note: The following tables also provide the net values of the current capacity and inrush current.

◆ Σ-7S SERVOPACKs

Main Circuit Power Supply	SERVO-PACK Model: SGD7S-	Power Supply Capacity per SERVO-PACK [kVA]* ¹	Current Capacity		Inrush Current		External Fuse				
			Main Circuit [Arms]* ¹	Control Power Supply [Arms]	Main Circuit [A0-p]	Control Power Supply [A0-p]	Order Number* ²	Current Rating [A]	Voltage Rating [Vdc]		
270 VDC	R70A	0.2	0.5	0.2	34	34	3,5URGJ17/16UL	16	400		
	R90A	0.3	1.0								
	1R6A	0.5	1.5								
	2R8A	1.0	3.0								
	3R8A	1.3	3.8	0.2			3,5URGJ17/40UL	40			
	5R5A	1.6	4.9								
	7R6A	2.3	6.9								
	120A	3.2	11	0.2			0.25	3,5URGJ17/63UL		63	
	120A □□□ 008										
	180A			4.0							14
	200A			5.9							20
	330A	7.5	34	0.3			68* ³ (5Ω external)	3,5URGJ17/100UL		100	
	470A	10.7	36								
	550A	14.6	48								
590A	21.7	68	0.4	114* ³ (3Ω external)	3,5URGJ23/160UL	160					
780A	29.6	92					3,5URGJ23/200UL	200			

*1. This is the net value at the rated load.

*2. These Fuses are manufactured by Mersen Japan.

*3. If you use a DC power supply input with any of the following SERVOPACKs, externally connect an inrush current limiting circuit and use the power ON and OFF sequences recommended by Yaskawa: SGD7S-330A, -470A, -550A, -590A, or -780A.

There is a risk of equipment damage.

For information on the power ON and OFF sequences, refer to the product manual for your SERVOPACK.

◆ Σ-7W/Σ-7C SERVOPACKS

Main Circuit Power Supply	SERVO-PACK Model: SGD7W- or SGD7C-	Power Supply Capacity per SERVO-PACK [kVA] ^{*1}	Current Capacity		Inrush Current		External Fuse		
			Main Circuit [Arms] ^{*1}	Control Power Supply [Arms]	Main Circuit [A0-p]	Control Power Supply [A0-p]	Order Number ^{*2}	Current Rating [A]	Voltage Rating [Vdc]
270 VDC	1R6A	1	3.0	0.25	34	34	3,5URGJ17/40UL	40	400
	2R8A	1.9	5.8					63	
	5R5A	3.2	9.7				3,5URGJ17/63UL	63	
	7R6A	4.5	14					63	

*1. This is the net value at the rated load.

*2. These Fuses are manufactured by Mersen Japan.

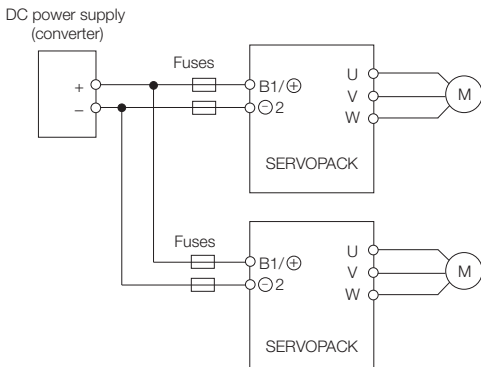

Note: If you connect more than one SERVOPACK to the same DC power supply, connect Fuses for each SERVOPACK.

3.4 Wire Sizes and Tightening Torques

SERVOPACK Main Circuit Wires

This section describes the main circuit wires for SERVOPACKs.



Important

These specifications are based on IEC/EN 61800-5-1, UL 61800-5-1, and CSA C22.2 No.274.

1. To comply with UL standards, use UL-compliant wires.
2. Use copper wires with a rated temperature of 75°C or higher.
3. Use wires with a rated withstand voltage of 300 V or higher.

Note: To use 600-V-grade heat-resistant polyvinyl chloride-insulated wire (HIV), use the following table as reference for the applicable wires.

- The specified wire sizes are for three bundled leads when the rated current is applied with a surrounding air temperature of 40°C.
- Select the wires according to the surrounding air temperature.

If you use a SERVOPACK that supports a Dynamic Brake Option and connect an External Dynamic Brake Resistor, refer to the following section.

 ◆ *Dynamic Brake Resistor Terminals: Σ -7S, Σ -7W, and Σ -7C SERVOPACKs on page 46*

◆ Σ -7S SERVOPACKs for Use with Three-Phase, 200-VAC Power Supplies

SERVO- PACK Model: SGD7S-	Terminal Symbols	Wire Size	Screw Size	Tightening Torque [N·m]
R70A	L1, L2, and L3	AWG16 (1.25 mm ²)	–	–
	U, V, and W*	AWG16 (1.25 mm ²)	–	–
	L1C and L2C	AWG16 (1.25 mm ²)	–	–
	B1/⊕ and B2	AWG16 (1.25 mm ²)	–	–
	⊕	AWG14 (2.0 mm ²) or larger	M4	1.2 to 1.4

Continued on next page.

Continued from previous page.

SERVO- PACK Model: SGD7S-	Terminal Symbols	Wire Size	Screw Size	Tightening Torque [N·m]
R90A	L1, L2, and L3	AWG16 (1.25 mm ²)	-	-
	U, V, and W*	AWG16 (1.25 mm ²)	-	-
	L1C and L2C	AWG16 (1.25 mm ²)	-	-
	B1/⊕ and B2	AWG16 (1.25 mm ²)	-	-
	⊕	AWG14 (2.0 mm ²) or larger	M4	1.2 to 1.4
1R6A	L1, L2, and L3	AWG16 (1.25 mm ²)	-	-
	U, V, and W*	AWG16 (1.25 mm ²)	-	-
	L1C and L2C	AWG16 (1.25 mm ²)	-	-
	B1/⊕ and B2	AWG16 (1.25 mm ²)	-	-
	⊕	AWG14 (2.0 mm ²) or larger	M4	1.2 to 1.4
2R8A	L1, L2, and L3	AWG16 (1.25 mm ²)	-	-
	U, V, and W*	AWG16 (1.25 mm ²)	-	-
	L1C and L2C	AWG16 (1.25 mm ²)	-	-
	B1/⊕ and B2	AWG16 (1.25 mm ²)	-	-
	⊕	AWG14 (2.0 mm ²) or larger	M4	1.2 to 1.4
3R8A	L1, L2, and L3	AWG16 (1.25 mm ²)	-	-
	U, V, and W*	AWG16 (1.25 mm ²)	-	-
	L1C and L2C	AWG16 (1.25 mm ²)	-	-
	B1/⊕ and B2	AWG16 (1.25 mm ²)	-	-
	⊕	AWG14 (2.0 mm ²) or larger	M4	1.2 to 1.4
5R5A	L1, L2, and L3	AWG16 (1.25 mm ²)	-	-
	U, V, and W*	AWG16 (1.25 mm ²)	-	-
	L1C and L2C	AWG16 (1.25 mm ²)	-	-
	B1/⊕ and B2	AWG16 (1.25 mm ²)	-	-
	⊕	AWG14 (2.0 mm ²) or larger	M4	1.2 to 1.4

Continued on next page.

Continued from previous page.

SERVO- PACK Model: SGD7S-	Terminal Symbols	Wire Size	Screw Size	Tightening Torque [N·m]
7R6A	L1, L2, and L3	AWG16 (1.25 mm ²)	–	–
	U, V, and W*	AWG16 (1.25 mm ²)	–	–
	L1C and L2C	AWG16 (1.25 mm ²)	–	–
	B1/⊕ and B2	AWG16 (1.25 mm ²)	–	–
	⊕	AWG14 (2.0 mm ²) or larger	M4	1.2 to 1.4
120A	L1, L2, and L3	AWG14 (2.0 mm ²)	–	–
	U, V, and W*	AWG14 (2.0 mm ²)	–	–
	L1C and L2C	AWG16 (1.25 mm ²)	–	–
	B1/⊕ and B2	AWG16 (1.25 mm ²)	–	–
	⊕	AWG14 (2.0 mm ²) or larger	M4	1.2 to 1.4
180A	L1, L2, and L3	AWG14 (2.0 mm ²)	M4	1.0 to 1.2
	U, V, and W*	AWG10 (5.5 mm ²)	M4	1.0 to 1.2
	L1C and L2C	AWG16 (1.25 mm ²)	M4	1.0 to 1.2
	B1/⊕ and B2	AWG16 (1.25 mm ²)	M4	1.0 to 1.2
	⊕	AWG14 (2.0 mm ²) or larger	M4	1.2 to 1.4
200A	L1, L2, and L3	AWG12 (3.5 mm ²)	M4	1.0 to 1.2
	U, V, and W*	AWG10 (5.5 mm ²)	M4	1.0 to 1.2
	L1C and L2C	AWG16 (1.25 mm ²)	M4	1.0 to 1.2
	B1/⊕ and B2	AWG16 (1.25 mm ²)	M4	1.0 to 1.2
	⊕	AWG14 (2.0 mm ²) or larger	M4	1.2 to 1.4
330A	L1, L2, and L3	AWG8 (8.0 mm ²)	M4	1.0 to 1.2
	U, V, and W*	AWG8 (8.0 mm ²)	M4	1.0 to 1.2
	L1C and L2C	AWG16 (1.25 mm ²)	M4	1.0 to 1.2
	B1/⊕ and B2	AWG14 (2.0 mm ²)	M4	1.0 to 1.2
	⊕	AWG14 (2.0 mm ²) or larger	M4	1.2 to 1.4

Continued on next page.

Continued from previous page.

SERVO- PACK Model: SGD7S-	Terminal Symbols	Wire Size	Screw Size	Tightening Torque [N·m]
470A	L1, L2, and L3	AWG8 (8.0 mm ²)	M5	2.2 to 2.4
	U, V, and W*	AWG6 (14 mm ²)	M5	2.2 to 2.4
	L1C and L2C	AWG16 (1.25 mm ²)	M5	2.2 to 2.4
	B1/⊕ and B2	AWG14 (2.0 mm ²)	M5	2.2 to 2.4
	⊕	AWG14 (2.0 mm ²) or larger	M5	2.2 to 2.4
550A	L1, L2, and L3	AWG8 (8.0 mm ²)	M5	2.2 to 2.4
	U, V, and W*	AWG4 (22 mm ²)	M5	2.2 to 2.4
	L1C and L2C	AWG16 (1.25 mm ²)	M5	2.2 to 2.4
	B1/⊕ and B2	AWG10 (5.5 mm ²)	M5	2.2 to 2.4
	⊕	AWG14 (2.0 mm ²) or larger	M5	2.2 to 2.4
590A	L1, L2, and L3	AWG4 (22 mm ²)	M6	2.7 to 3.0
	U, V, and W*	AWG4 (22 mm ²)	M6	2.7 to 3.0
	L1C and L2C	AWG16 (1.25 mm ²)	M6	2.7 to 3.0
	B1/⊕ and B2	AWG10 (5.5 mm ²)	M6	2.7 to 3.0
	⊕	AWG14 (2.0 mm ²) or larger	M6	2.7 to 3.0
780A	L1, L2, and L3	AWG3 (30 mm ²)	M6	2.7 to 3.0
	U, V, and W*	AWG3 (30 mm ²)	M6	2.7 to 3.0
	L1C and L2C	AWG16 (1.25 mm ²)	M6	2.7 to 3.0
	B1/⊕ and B2	AWG8 (8.0 mm ²)	M6	2.7 to 3.0
	⊕	AWG14 (2.0 mm ²) or larger	M6	2.7 to 3.0

* If you do not use the recommended Servomotor Main Circuit Cable, use this table to select wires.

◆ Σ -7S SERVOPACKs for Use with Single-Phase, 200-VAC Power Supplies

SERVO-PACK Model: SGD7S-	Terminal Symbols	Wire Size	Screw Size	Tightening Torque [N·m]
R70A	L1 and L2	AWG16 (1.25 mm ²)	–	–
	U, V, and W*	AWG16 (1.25 mm ²)	–	–
	L1C and L2C	AWG16 (1.25 mm ²)	–	–
	B1/⊕ and B2	AWG16 (1.25 mm ²)	–	–
	⊕	AWG14 (2.0 mm ²) or larger	M4	1.2 to 1.4
R90A	L1 and L2	AWG16 (1.25 mm ²)	–	–
	U, V, and W*	AWG16 (1.25 mm ²)	–	–
	L1C and L2C	AWG16 (1.25 mm ²)	–	–
	B1/⊕ and B2	AWG16 (1.25 mm ²)	–	–
	⊕	AWG14 (2.0 mm ²) or larger	M4	1.2 to 1.4
1R6A	L1 and L2	AWG16 (1.25 mm ²)	–	–
	U, V, and W*	AWG16 (1.25 mm ²)	–	–
	L1C and L2C	AWG16 (1.25 mm ²)	–	–
	B1/⊕ and B2	AWG16 (1.25 mm ²)	–	–
	⊕	AWG14 (2.0 mm ²) or larger	M4	1.2 to 1.4
2R8A	L1 and L2	AWG16 (1.25 mm ²)	–	–
	U, V, and W*	AWG16 (1.25 mm ²)	–	–
	L1C and L2C	AWG16 (1.25 mm ²)	–	–
	B1/⊕ and B2	AWG16 (1.25 mm ²)	–	–
	⊕	AWG14 (2.0 mm ²) or larger	M4	1.2 to 1.4
5R5A	L1 and L2	AWG14 (2.0 mm ²)	–	–
	U, V, and W*	AWG16 (1.25 mm ²)	–	–
	L1C and L2C	AWG16 (1.25 mm ²)	–	–
	B1/⊕ and B2	AWG16 (1.25 mm ²)	–	–
	⊕	AWG14 (2.0 mm ²) or larger	M4	1.2 to 1.4

Continued on next page.

Continued from previous page.

SERVO- PACK Model: SGD7S-	Terminal Symbols	Wire Size	Screw Size	Tightening Torque [N·m]
120A□□ □008	L1 and L2	AWG14 (2.0 mm ²)	M4	1.0 to 1.2
	U, V, and W*	AWG14 (2.0 mm ²)	M4	1.0 to 1.2
	L1C and L2C	AWG16 (1.25 mm ²)	M4	1.0 to 1.2
	B1/⊕ and B2	AWG16 (1.25 mm ²)	M4	1.0 to 1.2
	⊕	AWG14 (2.0 mm ²) or larger	M4	1.2 to 1.4

* If you do not use the recommended Servomotor Main Circuit Cable, use this table to select wires.

◆ Σ-7S SERVOPACKs for Use with Single-Phase, 100-VAC Power Supplies

SERVO- PACK Model: SGD7S-	Terminal Symbols	Wire Size	Screw Size	Tightening Torque [N·m]
R70F	L1 and L2	AWG16 (1.25 mm ²)	-	-
	U, V, and W*	AWG16 (1.25 mm ²)	-	-
	L1C and L2C	AWG16 (1.25 mm ²)	-	-
	B1 and B2	AWG16 (1.25 mm ²)	-	-
	⊕	AWG14 (2.0 mm ²) or larger	M4	1.2 to 1.4
R90F	L1 and L2	AWG16 (1.25 mm ²)	-	-
	U, V, and W*	AWG16 (1.25 mm ²)	-	-
	L1C and L2C	AWG16 (1.25 mm ²)	-	-
	B1 and B2	AWG16 (1.25 mm ²)	-	-
	⊕	AWG14 (2.0 mm ²) or larger	M4	1.2 to 1.4
2R1F	L1 and L2	AWG16 (1.25 mm ²)	-	-
	U, V, and W*	AWG16 (1.25 mm ²)	-	-
	L1C and L2C	AWG16 (1.25 mm ²)	-	-
	B1 and B2	AWG16 (1.25 mm ²)	-	-
	⊕	AWG14 (2.0 mm ²) or larger	M4	1.2 to 1.4



Continued on next page.

Continued from previous page.

SERVO-PACK Model: SGD7S-	Terminal Symbols	Wire Size	Screw Size	Tightening Torque [N·m]
2R8F	L1 and L2	AWG14 (2.0 mm ²)	-	-
	U, V, and W*	AWG16 (1.25 mm ²)	-	-
	L1C and L2C	AWG16 (1.25 mm ²)	-	-
	B1 and B2	AWG16 (1.25 mm ²)	-	-
		AWG14 (2.0 mm ²) or larger	M4	1.2 to 1.4

* If you do not use the recommended Servomotor Main Circuit Cable, use this table to select wires.

◆ Σ-7S SERVOPACKs for Use with DC Power Supplies

SERVO-PACK Model: SGD7S-	Terminal Symbols* ¹	Wire Size	Screw Size	Tightening Torque [N·m]
R70A	U, V, and W* ²	AWG16 (1.25 mm ²)	-	-
	L1C and L2C	AWG16 (1.25 mm ²)	-	-
	B1/⊕ and ⊖2	AWG16 (1.25 mm ²)	-	-
		AWG14 (2.0 mm ²) or larger	M4	1.2 to 1.4
R90A	U, V, and W* ²	AWG16 (1.25 mm ²)	-	-
	L1C and L2C	AWG16 (1.25 mm ²)	-	-
	B1/⊕ and ⊖2	AWG16 (1.25 mm ²)	-	-
		AWG14 (2.0 mm ²) or larger	M4	1.2 to 1.4
1R6A	U, V, and W* ²	AWG16 (1.25 mm ²)	-	-
	L1C and L2C	AWG16 (1.25 mm ²)	-	-
	B1/⊕ and ⊖2	AWG16 (1.25 mm ²)	-	-
		AWG14 (2.0 mm ²) or larger	M4	1.2 to 1.4







Continued on next page.

Continued from previous page.

SERVO- PACK Model: SGD7S-	Terminal Symbols*1	Wire Size	Screw Size	Tighten- ing Torque [N·m]
2R8A	U, V, and W*2	AWG16 (1.25 mm ²)	–	–
	L1C and L2C	AWG16 (1.25 mm ²)	–	–
	B1/⊕ and ⊖2	AWG16 (1.25 mm ²)	–	–
	⊕	AWG14 (2.0 mm ²) or larger	M4	1.2 to 1.4
3R8A	U, V, and W*2	AWG16 (1.25 mm ²)	–	–
	L1C and L2C	AWG16 (1.25 mm ²)	–	–
	B1/⊕ and ⊖2	AWG16 (1.25 mm ²)	–	–
	⊕	AWG14 (2.0 mm ²) or larger	M4	1.2 to 1.4
5R5A	U, V, and W*2	AWG16 (1.25 mm ²)	–	–
	L1C and L2C	AWG16 (1.25 mm ²)	–	–
	B1/⊕ and ⊖2	AWG16 (1.25 mm ²)	–	–
	⊕	AWG14 (2.0 mm ²) or larger	M4	1.2 to 1.4
7R6A	U, V and W*2	AWG16 (1.25 mm ²)	–	–
	L1C and L2C	AWG16 (1.25 mm ²)	–	–
	B1/⊕ and ⊖2	AWG16 (1.25 mm ²)	–	–
	⊕	AWG14 (2.0 mm ²) or larger	M4	1.2 to 1.4
120A (3-phase 200-VAC input)	U, V, and W*2	AWG14 (2.0 mm ²)	–	–
	L1C and L2C	AWG16 (1.25 mm ²)	–	–
	B1/⊕ and ⊖2	AWG14 (2.0 mm ²)	–	–
	⊕	AWG14 (2.0 mm ²) or larger	M4	1.2 to 1.4
120A□□ □008 (single- phase 200-VAC input)	U, V, and W*2	AWG14 (2.0 mm ²)	M4	1.0 to 1.2
	L1C and L2C	AWG16 (1.25 mm ²)	M4	1.0 to 1.2
	B1/⊕ and ⊖2	AWG14 (2.0 mm ²)	M4	1.0 to 1.2
	⊕	AWG14 (2.0 mm ²) or larger	M4	1.2 to 1.4

Continued on next page.

Continued from previous page.

SERVO- PACK Model: SGD7S-	Terminal Symbols*1	Wire Size	Screw Size	Tighten- ing Torque [N·m]
180A	U, V, and W*2	AWG10 (5.5 mm ²)	M4	1.0 to 1.2
	L1C and L2C	AWG16 (1.25 mm ²)	M4	1.0 to 1.2
	B1/⊕ and ⊖2	AWG10 (5.5 mm ²)	M4	1.0 to 1.2
		AWG14 (2.0 mm ²) or larger	M4	1.2 to 1.4
200A	U, V, and W*2	AWG10 (5.5 mm ²)	M4	1.0 to 1.2
	L1C and L2C	AWG16 (1.25 mm ²)	M4	1.0 to 1.2
	B1/⊕ and ⊖2	AWG10 (5.5 mm ²)	M4	1.0 to 1.2
		AWG14 (2.0 mm ²) or larger	M4	1.2 to 1.4
330A	U, V, and W*2	AWG8 (8.0 mm ²)	M4	1.0 to 1.2
	L1C and L2C	AWG16 (1.25 mm ²)	M4	1.0 to 1.2
	B1/⊕ and ⊖2	AWG8 (8.0 mm ²)	M4	1.0 to 1.2
		AWG14 (2.0 mm ²) or larger	M4	1.2 to 1.4
470A	U, V, and W*2	AWG6 (14 mm ²)	M5	2.2 to 2.4
	L1C and L2C	AWG16 (1.25 mm ²)	M5	2.2 to 2.4
	B1/⊕ and ⊖2	AWG8 (8.0 mm ²)	M5	2.2 to 2.4
		AWG14 (2.0 mm ²) or larger	M5	2.2 to 2.4
550A	U, V, and W*2	AWG4 (22 mm ²)	M5	2.2 to 2.4
	L1C and L2C	AWG16 (1.25 mm ²)	M5	2.2 to 2.4
	B1/⊕ and ⊖2	AWG6 (14 mm ²)	M5	2.2 to 2.4
		AWG14 (2.0 mm ²) or larger	M5	2.2 to 2.4
590A	U, V, and W*2	AWG4 (22 mm ²)	M6	2.7 to 3.0
	L1C and L2C	AWG16 (1.25 mm ²)	M6	2.7 to 3.0
	B1/⊕ and ⊖2	AWG3 (30 mm ²)	M6	2.7 to 3.0
		AWG14 (2.0 mm ²) or larger	M6	2.7 to 3.0

Continued on next page.

Continued from previous page.

SERVO- PACK Model: SGD7S-	Terminal Symbols* ¹	Wire Size	Screw Size	Tighten- ing Torque [N·m]
780A	U, V, and W* ²	AWG3 (30 mm ²)	M6	2.7 to 3.0
	L1C and L2C	AWG16 (1.25 mm ²)	M6	2.7 to 3.0
	B1/⊕ and ⊖2	AWG3 (30 mm ²)	M6	2.7 to 3.0
	⊕	AWG14 (2.0 mm ²) or larger	M6	2.7 to 3.0

*1. Do not wire the following terminals: L1, L2, L3, B2, B3, ⊖1, and ⊖ terminals.

*2. If you do not use the recommended Servomotor Main Circuit Cable, use this table to select wires.

◆ Σ -7W/ Σ -7C SERVOPACKs for Use with Three-Phase, 200-VAC Power Supplies

SERVO- PACK Model: SGD7W- or SGD7C-	Terminal Symbols	Wire Size	Screw Size	Tightening Torque [N·m]
1R6A	L1, L2, and L3	AWG16 (1.25 mm ²)	-	-
	UA, VA, WA, UB, VB, and WB*	AWG16 (1.25 mm ²)	-	-
	L1C and L2C	AWG16 (1.25 mm ²)	-	-
	B1/⊕ and B2	AWG16 (1.25 mm ²)	-	-
	⊕	AWG14 (2.0 mm ²) or larger	M4	1.2 to 1.4
2R8A	L1, L2, and L3	AWG14 (2.0 mm ²)	-	-
	UA, VA, WA, UB, VB, and WB*	AWG16 (1.25 mm ²)	-	-
	L1C and L2C	AWG16 (1.25 mm ²)	-	-
	B1/⊕ and B2	AWG16 (1.25 mm ²)	-	-
	⊕	AWG14 (2.0 mm ²) or larger	M4	1.2 to 1.4

Continued on next page.

Continued from previous page.

SERVO- PACK Model: SGD7W- or SGD7C-	Terminal Symbols	Wire Size	Screw Size	Tightening Torque [N·m]
5R5A	L1, L2, and L3	AWG14 (2.0 mm ²)	-	-
	UA, VA, WA, UB, VB, and WB*	AWG16 (1.25 mm ²)	-	-
	L1C and L2C	AWG16 (1.25 mm ²)	-	-
	B1/⊕ and B2	AWG14 (2.0 mm ²)	-	-
	⊖	AWG14 (2.0 mm ²) or larger	M4	1.2 to 1.4
7R6A	L1, L2, and L3	AWG14 (2.0 mm ²)	-	-
	UA, VA, WA, UB, VB, and WB*	AWG16 (1.25 mm ²)	-	-
	L1C and L2C	AWG16 (1.25 mm ²)	-	-
	B1/⊕ and B2	AWG14 (2.0 mm ²)	-	-
	⊖	AWG14 (2.0 mm ²) or larger	M4	1.2 to 1.4

* If you do not use the recommended Servomotor Main Circuit Cable, use this table to select wires.

◆ Σ -7W/ Σ -7C SERVOPACKs for Use with Single-Phase, 200-VAC Power Supplies

SERVO- PACK Model: SGD7W- or SGD7C-	Terminal Symbols	Wire Size	Screw Size	Tightening Torque [N·m]
1R6A	L1 and L2	AWG16 (1.25 mm ²)	-	-
	UA, VA, WA, UB, VB, and WB*	AWG16 (1.25 mm ²)	-	-
	L1C and L2C	AWG16 (1.25 mm ²)	-	-
	B1/⊕ and B2	AWG16 (1.25 mm ²)	-	-
	⊖	AWG14 (2.0 mm ²) or larger	M4	1.2 to 1.4

Continued on next page.

Continued from previous page.

SERVO-PACK Model: SGD7W- or SGD7C-	Terminal Symbols	Wire Size	Screw Size	Tightening Torque [N·m]
2R8A	L1 and L2	AWG14 (2.0 mm ²)	–	–
	UA, VA, WA, UB, VB, and WB*	AWG16 (1.25 mm ²)	–	–
	L1C and L2C	AWG16 (1.25 mm ²)	–	–
	B1/⊕ and B2	AWG16 (1.25 mm ²)	–	–
	⊖	AWG14 (2.0 mm ²) or larger	M4	1.2 to 1.4
5R5A	L1 and L2	AWG14 (2.0 mm ²)	–	–
	UA, VA, WA, UB, VB, and WB*	AWG16 (1.25 mm ²)	–	–
	L1C and L2C	AWG16 (1.25 mm ²)	–	–
	B1/⊕ and B2	AWG14 (2.0 mm ²)	–	–
	⊖	AWG14 (2.0 mm ²) or larger	M4	1.2 to 1.4

* If you do not use the recommended Servomotor Main Circuit Cable, use this table to select wires.

◆ Σ-7W/Σ-7C SERVOPACKs for Use with DC Power Supplies

SERVO-PACK Model: SGD7W- or SGD7C-	Terminal Symbols* ¹	Wire Size	Screw Size	Tightening Torque [N·m]
1R6A	UA, VA, WA, UB, VB, and WB* ²	AWG16 (1.25 mm ²)	–	–
	L1C and L2C	AWG16 (1.25 mm ²)	–	–
	B1/⊕ and ⊖	AWG16 (1.25 mm ²)	–	–
	⊖	AWG14 (2.0 mm ²) or larger	M4	1.2 to 1.4

Continued on next page.

Continued from previous page.

SERVO- PACK Model: SGD7W- or SGD7C-	Terminal Symbols*1	Wire Size	Screw Size	Tighten- ing Torque [N·m]
2R8A	UA, VA, WA, UB, VB, and WB*2	AWG16 (1.25 mm ²)	–	–
	L1C and L2C	AWG16 (1.25 mm ²)	–	–
	B1/⊕ and ⊖2	AWG16 (1.25 mm ²)	–	–
	⊕	AWG14 (2.0 mm ²) or larger	M4	1.2 to 1.4
5R5A	UA, VA, WA, UB, VB, and WB*2	AWG16 (1.25 mm ²)	–	–
	L1C and L2C	AWG16 (1.25 mm ²)	–	–
	B1/⊕ and ⊖2	AWG14 (2.0 mm ²)	–	–
	⊕	AWG14 (2.0 mm ²) or larger	M4	1.2 to 1.4
7R6A	UA, VA, WA, UB, VB, and WB*2	AWG16 (1.25 mm ²)	–	–
	L1C and L2C	AWG16 (1.25 mm ²)	–	–
	B1/⊕ and ⊖2	AWG14 (2.0mm ²)	–	–
	⊕	AWG14 (2.0 mm ²) or larger	M4	1.2 to 1.4

- *1. Do not wire the following terminals: L1, L2, L3, B2, B3, ⊖1, and ⊖ terminals.
- *2. If you do not use the recommended Servomotor Main Circuit Cable, use this table to select wires.

◆ Dynamic Brake Resistor Terminals: Σ-7S, Σ-7W, and Σ-7C SERVOPACKS

These terminals are used if you use a SERVOPACK that supports a Dynamic Brake Option and connect an External Dynamic Brake Resistor.

SERVOPACK Models		Terminal Symbols	Wire Size	Screw Size	Tightening Torque [N·m]
SGD7S-	R70A, R90A, 1R6A, 2R8A, R70F, R90F, 2R1F, and 2R8F	-	-	-	-
	3R8A, 5R5A, 7R6A, 120A, 180A, 200A, and 330A	D1 and D2	AWG14 (2.0 mm ²) to AWG18 (0.9 mm ²)*	-	-
	470A and 550A	D1 and D2	AWG12 (3.5 mm ²) to AWG18 (0.9 mm ²)*	M4	1.0 to 1.2
	590A and 780A	D1 and D2	AWG12 (3.5 mm ²) to AWG18 (0.9 mm ²)*	M4	1.6 to 1.8
SGD7W-	1R6A and 2R8A	-	-	-	-
	5R5A and 7R6A	D1A, D2A, D1B, and D2B	AWG14 (2.0 mm ²) to AWG18 (0.9 mm ²)*	-	-
SGD7C-	1R6A and 2R8A	-	-	-	-
	5R5A and 7R6A	D1A, D2A, D1B, and D2B	AWG14 (2.0 mm ²) to AWG18 (0.9 mm ²)*	-	-

* Any wire sizes within the ranges given in this table can be used for the External Dynamic Brake Resistor.

◆ Wire Types

The following table shows the wire sizes and allowable currents for three bundled leads.

HIV Specifications*		Allowable Current at Surrounding Air Temperatures [Arms]		
Nominal Cross-sectional Area [mm ²]	Configuration [Wires/mm]	30°C	40°C	50°C
0.9	7/0.4	15	13	11
1.25	7/0.45	16	14	12
2.0	7/0.6	23	20	17
3.5	7/0.8	32	28	24
5.5	7/1.0	42	37	31
8.0	7/1.2	52	46	39
14.0	7/1.6	75	67	56
22.0	7/2.0	98	87	73
38.0	7/2.6	138	122	103

* This is reference data based on JIS C3317 600-V-grade heat-resistant polyvinyl chloride-insulated wires (HIV).

4 Maintenance and Inspection

This section describes the inspection and maintenance of a SERVOPACK.

4.1 Inspections

Perform the inspections given in the following table at least once every year for the SERVOPACK. Daily inspections are not required.

Item	Frequency	Inspection	Correction
External Appearance	At least once a year	Check for dust, dirt, and oil on the surfaces.	Clean with compressed air or a cloth.
Loose Screws		Check for loose terminal block and connector screws and for other loose parts.	Tighten any loose screws or other loose parts.

4.2 Guidelines for Part Replacement

The following electric or electronic parts are subject to mechanical wear or deterioration over time. Use one of the following methods to check the standard replacement period.

- Use the service life prediction function of the SERVOPACK.
- Use the following table.

When any standard replacement period is close to expiring, contact your Yaskawa representative. After an examination of the part in question, we will determine whether the part should be replaced.



The parameters of any SERVOPACKS that are sent to Yaskawa for part replacement are reset to the default settings before they are returned to you. Always keep a record of the parameter settings. And, always confirm that the parameters are properly set before starting operation.

Part	Standard Replacement Period	Remarks
Cooling Fan	4 to 5 years	The standard replacement periods given on the left are for the following operating conditions. Surrounding air temperature: Annual average of 30°C Load ratio: 80% max. Operation rate: 20 hours/day max.
Electrolytic Capacitor	10 years	

Continued on next page.

Continued from previous page.

Part	Standard Replacement Period	Remarks
Relays	100,000 power ON operations	Frequency of turning ON the power supply: Approx. once an hour
Battery	3 years without power supplied	Surrounding air temperature without power supplied: 20°C

5 Conditions for Compliance with EC Directives

5.1 Conditions for Compliance with the EMC Directive



For a Servomotor and SERVOPACK combination to comply with the EMC Directive, ferrite cores, Noise Filters, Surge Absorbers, and possibly other devices must be used. These Yaskawa products are designed to be built into equipment. Therefore, you must implement EMC measures and confirm compliance for the final equipment. The applicable standards are EN 55011 group 1 class A, EN 61000-6-2, EN 61000-6-4, and EN 61800-3 (category C2, second environment).

For information on EMC installation conditions, refer to the product manual for your SERVOPACK.

5.2 Conditions for Compliance with the Low Voltage Directive

The products have been tested according to IEC/EN 61800-5-1 and EN 50178, and they comply the Low Voltage Directive. To comply with the Low Voltage Directive, the equipment or machine in which you use the products must meet the following conditions.

Installation Environment and Insulation Conditions

Overvoltage Category	III	Compliance standards: IEC 60364-4-44 and IEC 60664-1
Pollution Degree	2	Compliance standards: IEC 60364-4-44 and IEC 60664-1
Surrounding Air Temperature	-5°C to 60°C*1	Refer to the following section for application at 55°C or higher.  ◆ <i>Derating Specifications on page 20</i>
Altitude	2,000 m max.*2	Refer to the following section for application at 1,000 m or higher.  ◆ <i>Derating Specifications on page 20</i>
Degree of Protection	Refer to 2 <i>Installation</i> on page 18.	Compliance standard: IEC 60529
Protective Class	I	Compliance standard: IEC 61140
Input Power Supply	AC power supply	CE Marking is not applicable if a DC power supply input is used.

*1. If you use a Σ -7C SERVOPACK, or if you use a Σ -7-Series SERVOPACK together with a Σ -V-Series Option Module, use them at a surrounding air temperature of 0°C to 55°C.

*2. If you use a Σ -7-Series SERVOPACK together with a Σ -V-Series Option Module, use them at an altitude of 1,000 m or less.

External Power Supply for Control Circuits

For the DC power supply for the control signal I/O circuits (CN1 and CN8), use a power supply device with double insulation or reinforced insulation.

Installation of a Short-Circuit Protection Element

Always use Fuses that comply with UL standards on the main circuit power supply line.

Use either non-time delay fuses or semiconductor fuses.



Refer to 3.3 *Molded-Case Circuit Breakers and Fuses* on page 29 for information on selecting fuse voltage and current ratings.

6 Conditions for Compliance with UL/cUL Standards

The products have been tested according to the following standards and they comply the UL/cUL standards. To comply with the UL/cUL standards, the equipment or machine in which you use the products must meet the following conditions.

- UL: UL 61800-5-1 (Adjustable Speed Electrical Power Drive Systems)
- cUL: CSA C22.2 No.274 (Adjustable speed drives)

Installation Environment and Insulation Conditions

Overvoltage Category	III	Compliance standards: IEC 60364-4-44 and IEC 60664-1
Pollution Degree	2	Compliance standards: IEC 60364-4-44 and IEC 60664-1
Surrounding Air Temperature	-5°C to 60°C* ¹	Refer to the following section for application at 55°C or higher.  ◆ <i>Derating Specifications on page 20</i>
Altitude	2,000 m max.* ²	Refer to the following section for application at 1,000 m or higher.  ◆ <i>Derating Specifications on page 20</i>
Degree of Protection	Refer to 2 <i>Installation</i> on page 18.	Compliance standard: IEC 60529
Protective Class	I	Compliance standard: IEC 61140
Input Power Supply	AC power supply	UL/cUL standards are not applicable if a DC power supply input is used.

- *1. If you use a Σ -7C SERVOPACK, or if you use a Σ -7-Series SERVOPACK together with a Σ -V-Series Option Module, use them at a surrounding air temperature of 0°C to 55°C.
- *2. If you use a Σ -7-Series SERVOPACK together with a Σ -V-Series Option Module, use them at an altitude of 1,000 m or less.

External Power Supply for Control Circuits

The DC power supplies connected to the control signal I/O circuits (CN1 and CN8) must meet one of the following conditions.

- Use a class 2 power supply (compliance standard: UL 1310).
- Connect the control signal I/O circuits (CN1 and CN8) to a circuit with a maximum voltage of 30 Vrms and a peak voltage of 42.4 V that uses a UL 5085-3 (previous standard: UL 1585)-compliant class 2 transformer as its power supply.
- Use an isolated power supply with a maximum voltage of 30 Vrms and a peak voltage of 42.4 V that is isolated by double or reinforced insulation.

Wiring the Main Circuit Terminals

Wire the main circuit terminals according to the National Electrical Code (NEC/NFPA70) of the United States. However, Σ -7W and Σ -7C SERVOPACKs are suitable for the Motor Group Installation defined in UL 61800-5-1.

◆ SERVOPACKs with Enclosed Main Circuit Connectors and Motor Connectors

The following models comply with UL/cUL standards. Always use the connectors that are enclosed with the SERVOPACK to wire the main circuit terminals.

- SGD7S models: SGD7S-R70A, -R90A, -1R6A, -2R8A, -3R8A, -5R5A, -7R6A, -120A (3-phase 200-VAC input), -R70F, -R90F, -2R1F, and -2R8F
- All SGD7W models
- All SGD7C models

◆ SERVOPACKs with Screw Terminal Blocks for the Main Circuit Terminals

The following models comply with UL/cUL standards. Always connect closed-loop crimp terminals that comply with UL standards to the wires to connect to the main circuit terminals.

- SGD7S models: SGD7S-120A□□□008 (single-phase 200-VAC input), -180A, -200A, -330A, -470A, -550A, -590A, and -780A

Note: 1. Use the tool recommended by the crimp terminal manufacturer to attach the crimp terminals.

2. Use copper wires that withstand 75°C or the equivalent.
3. Refer to the following section for the wire sizes and tightening torques. Use the maximum tightening torque given in the following section to connect the wires.

 **3.4 Wire Sizes and Tightening Torques on page 33**

4. Refer to the following section for the recommended UL-compliant closed-loop crimp terminals and insulating sleeves.

 **9 Crimp Terminals and Insulating Sleeves on page 61**

6 Conditions for Compliance with UL/cUL Standards

5. A Terminal Kit for specific connection terminals is packed with the SERVOPACKs given in the following table. If you connect a cable to the connection terminals given in the following table, use the enclosed Terminal Kit.

SERVO- PACK Model: SGD7S-	Con- nec- tion Ter- minals	Closed-loop Crimp Termi- nal Model (From J.S.T. Mfg. Co., Ltd.)	Insulating Sleeve Model (From Tokyo Dip Co., Ltd)	Terminal Kit Model (Crimp Terminals and Slaves for One SERVOPACK)
180A, 200A	U, V, and W (motor main cir- cuit)	5.5-S4	TP-005 (black)	JZSP-C7T9-200A-E: 1 set

Installing Branch Circuit Protection and Short-Circuit Current Rating

To provide protection for short-circuit accidents in internal circuits, always connect molded-case circuit breakers or Fuses on the input side of the SERVOPACK as branch circuit protective devices.

Use UL-listed molded-case circuit breakers and UL-recognized fuses.

Σ -7W and Σ -7C SERVOPACKs are applicable to the Motor Group Installation defined in UL 61800-5-1 as long as the following conditions are met.

- The Σ -7W or Σ -7C SERVOPACK must be used in a circuit that provides the short-circuit current rating (SCCR) given in the following table.
- The Σ -7W or Σ -7C SERVOPACK must be protected by one of the branch circuit protection devices given in the following table.

The maximum applicable voltage for compliance with UL/cUL standards is given below regardless of the short-circuit current rating.

◆ **200 V Class: 240 Vrms**

◆ **100 V Class: 120 Vrms**

The short-circuit current rating (SCCR) of 100-V Class Σ -7S SERVOPACKs is 10,000 Arms (sine wave).

They must be used with UL-listed fuses or molded-case circuit breakers, in accordance with the guidelines of the National Electrical Code (NEC).

For 200-V Class SERVOPACKs, the short-circuit current rating (SCCR) of the SERVOPACK depends on the type of branch circuit protective device that you connect.

■ **Short-Circuit Current Rating (SCCR): 5,000 Arms (Sine Wave)**

Use Class CC, Class J, or Class T fuses for time delay fuses and non-time delay fuses.

• **Σ-7S SERVOPACKs**

SERVOPACK Model: SGD7S-	Rated Output Current [Arms]	Maximum Current Rating of Molded-Case Circuit Breaker [A]	Maximum Current Rating of Time Delay Fuse [A]	Maximum Current Rating of Non-Time Delay Fuse [A]
R70A	0.66	15	1	1
R90A	0.91	15	1*1	3
1R6A	1.6	15	—*2	6
2R8A	2.8	15	3*1	6
3R8A	3.8	15	6	10
5R5A	5.5	15	6*1	15
7R6A	7.6	15	10	20
120A (3-phase 200-VAC input)	11.6	20	20	30
120A□□□008 (single-phase 200-VAC input)	11.6	30	25	45
180A	18.5	30	30	50
200A	19.6	30	30	50
330A	32.9	80	50	90
470A	46.9	110	80	125
550A	54.7	125	90	150
590A	58.6	125	100	175
780A	78	175	125	225

*1. For a single-phase power supply, there are no applicable time delay fuses.

*2. There are no applicable time delay fuses.

6 Conditions for Compliance with UL/cUL Standards

• Σ-7W/Σ-7C SERVOPACKS

SERVOPACK Model: SGD7W- or SGD7C-	Rated Output Current [Arms]	Maximum Current Rating of Molded-Case Circuit Breaker [A]	Maximum Current Rating of Time Delay Fuse [A]	Maximum Current Rating of Non-Time Delay Fuse [A]
1R6A	1.6	15	3*	6
2R8A	2.8	15	6*	15
5R5A	5.5	20	15	30
7R6A	7.6	30	25	45

* For a single-phase power supply, there are no applicable time delay fuses.

■ Short-Circuit Current Rating (SCCR): 42,000 Arms (Sine Wave)

• Σ-7S SERVOPACKS

SERVOPACK Model: SGD7S-	Semiconductor Fuse Model*	Current Rating of Semiconductor Fuse [A]	Voltage Rating of Semiconductor Fuse [V]
R70A	FWH-35B	35	500
R90A			
1R6A			
2R8A			
3R8A	FWH-45B	45	
5R5A			
7R6A			
120A (3-phase 200-VAC input)			
120A□□□008 (single-phase 200-VAC input)	FWH-70B	70	
180A			
200A			
330A	FWH-100B	100	
470A	FWH-175B	175	
550A			
590A	FWH-200B	200	
780A			

* These Fuses are manufactured by Bussmann.

• Σ-7W/Σ-7C SERVOPACKs

SERVOPACK Model: SGD7W- or SGD7C-	Semiconductor Fuse Model*	Current Rating of Semiconductor Fuse [A]	Voltage Rating of Semiconductor Fuse [V]
1R6A	FWH-45B	45	500
2R8A			
5R5A	FWH-70B	70	
7R6A			

* These Fuses are manufactured by Bussmann.

Attaching of Warning Label Concerning Safe Handling During Maintenance and Inspection

In order to specify the instructions for the safe handling of this product for inspection and maintenance personnel, a self-adhesive warning label is included in the box with this SERVOPACK.

Affix this label to the inside of the enclosure (panel) in which the SERVOPACK is installed in a location that is visible during maintenance.

Servomotor Overtemperature Protection

Motor overtemperature protection that complies with UL standards (i.e., has speed-sensitive overload protection) is not provided. Motor overtemperature protection must be provided in the end use when required by the NEC/NFPA70 (Article 430, Chapter X, 430.126).

When used with a Yaskawa SGM□□ Servomotor, external overtemperature protection may not be needed because the motor is rated for continuous torque from 0 to the rated speed.

7 Information on Hazardous Substances in Revised China RoHS (Labeling of Environment-friendly Use Period)

(基于“修订版中国 RoHS” (张贴环境保护使用期限) 的产品中含有有害物质的信息)

This is based on the “Management Methods for the Restriction of the Use of Hazardous Substances in Electrical and Electronic Products.”

本资料根据中国《电器电子产品有害物质限制使用管理办法》制定。

Contents of hazardous substances in products
产品中有毒物质的名称及含量

Parts Name 部件名称	Hazardous substances 有害物质					
	Lead 铅 (Pb)	Mercury 汞 (Hg)	Cad- mium 镉 (Cd)	Hexava- lent chro- mium 六价铬 (Cr (VI))	Polybro- minated biphenyls 多溴联苯 (PBB)	Polybromi- nated diphe- nyl ethers 多溴二苯醚 (PBDE)
Circuit Board 实装基板	×	○	○	○	○	○
Electronic parts 电子元件	×	○	○	○	○	○
Heat sink 散热器	×	○	○	○	○	○
Mechanical parts 机械元件	×	○	○	○	○	○

This table has been prepared in accordance with the provisions outlined in SJ/T 11364.

本表格依据 SJ/T 11364 的规定编制。

○: Indicates that said hazardous substance contained in all of the homogeneous materials for this part is below or equal to the limit requirement of GB/T 26572.

×: Indicates that said hazardous substance contained in at least one of the homogeneous materials used for this part is above the limit requirement of GB/T 26572.

○: 表示该有害物质在该部件所有均质材料中的含量均在 GB/T 26572 规定的限量要求以下。

×: 表示该有害物质至少在该部件的某一均质材料中的含量超出 GB/T 26572 规定的限量要求。

7 Information on Hazardous Substances in Revised China RoHS (Labeling of Environment-friendly Use Period)

Note: This product complies with EU RoHS directives.

In the above table, “x” indicates that hazardous substances that are exempt from EU RoHS directives are contained.

注：本产品符合欧洲的 RoHS 指令。

上表中的“x”表示含有欧盟 RoHS 指令豁免的有害物质。

8

Precautions for Korean Radio Waves Act (한국 전파법에 관한 주의사항)

These products confirm to broadcast and communications equipment for business use (Class A) and are designed for use in locations other than in ordinary houses.

KC 마크가 부착되어 있는 제품은 한국 전파법에 적합한 제품입니다. 한국에서 사용할 경우에는 아래 사항에 주의하여 주십시오 .

사용자 안내문

이 기기는 업무용 환경에서 사용할 목적으로 적합성평가를 받은 기기로서 가정용 환경에서 사용하는 경우 전파간섭의 우려가 있습니다 .

(주) 사용자 안내문은 “ 업무용 방송통신기자재 ” 에만 적용한다 .

9 Crimp Terminals and Insulating Sleeves

If you use crimp terminals for wiring, use insulating sleeves. Do not allow the crimp terminals to come close to adjacent terminals or the case.



To comply with UL standards, you must use UL-compliant closed-loop crimp terminals and insulating sleeves for the main circuit terminals. Use the tool recommended by the crimp terminal manufacturer to attach the crimp terminals.

The following tables give the recommended tightening torques, closed-loop crimp terminals, and insulating sleeves in sets. Use the set that is suitable for your model and wire size.

If you use a SERVOPACK that supports a Dynamic Brake Option and connect an External Dynamic Brake Resistor, refer to the following section.

 **Dynamic Brake Resistor Terminals:** Σ -7S, Σ -7W, and Σ -7C SERVOPACKs on page 66



Σ -7S SERVOPACKs for Use with Three-Phase, 200-VAC or DC Power Supplies

SERVOPACK Model: SGD7S-	Main Circuit Terminals	Screw Size	Tightening Torque [N·m]	Crimp Terminal Horizontal Width	Recommended Wire Size	Crimp Terminal Model	Crimping Tool	Die	Insulating Sleeve Model
						From J.S.T. Mfg. Co., Ltd.			
R70A, R90A, 1R6A, 2R8A, 3R8A, 5R5A, 7R6A, and 120A	Connector	-							
		M4	1.2 to 1.4	10 mm max.	AWG14 (2.0 mm ²)	R2-4	YHT-2210	-	-
180A and 200A	Terminal block	M4	1.0 to 1.2	7.7 mm max.	AWG10 (5.5 mm ²)	5.5-S4	YHT-2210	-	TP-005
					AWG14 (2.0 mm ²)	2-M4		-	TP-003
					AWG16 (1.25 mm ²)			-	
		M4	1.2 to 1.4	10 mm max.	AWG14 (2.0 mm ²)	R2-4	YHT-2210	-	-

Continued on next page.

9 Crimp Terminals and Insulating Sleeves

Continued from previous page.

SERVOPACK Model: SGD7S-	Main Circuit Terminals	Screw Size	Tightening Torque [N·m]	Crimp Terminal Horizontal Width	Recommended Wire Size	Crimp Terminal Model	Crimping Tool	Die	Insulating Sleeve Model
						From J.S.T. Mfg. Co., Ltd.			
330A	Terminal block	M4	1.0 to 1.2	9.9 mm max.	AWG8 (8.0 mm ²)	8-4NS	YPT-60N	TD-121 TD-111	TP-008
					AWG14 (2.0 mm ²)	R2-4	YHT-2210	-	TP-003
					AWG16 (1.25 mm ²)			-	
		M4	1.2 to 1.4	10 mm max.	AWG14 (2.0 mm ²)	R2-4	YHT-2210	-	-
470A, 550A	Terminal block	M5	2.2 to 2.4	13 mm max.	AWG4 (22 mm ²)	22-S5	YPT-60N	TD-123 TD-112	TP-022
					AWG6 (14 mm ²)	R14-5		TD-122 TD-111	TP-014
					AWG8 (8.0 mm ²)	R8-5		TD-121 TD-111	TP-008
					AWG10 (5.5 mm ²)	R5.5-5	YHT-2210	-	TP-005
					AWG14 (2.0 mm ²)	R2-5		-	TP-003
					AWG16 (1.25 mm ²)			-	
		M5	2.2 to 2.4	12 mm max.	AWG14 (2.0 mm ²)	R2-5	YHT-2210	-	-



Continued on next page.

9 Crimp Terminals and Insulating Sleeves

Continued from previous page.

SERVOPACK Model: SGD7S-	Main Circuit Terminals	Screw Size	Tightening Torque [N·m]	Crimp Terminal Horizontal Width	Recommended Wire Size	Crimp Terminal Model	Crimping Tool	Die	Insulating Sleeve Model
						From J.S.T. Mfg. Co., Ltd.			
590A, 780A	Terminal block	M6	2.7 to 3.0	18 mm max.	AWG3 (30 mm ²)	38-S6	YPT-60N	TD-124 TD-112	TP-038
					AWG4 (22 mm ²)	R22-6		TD-123 TD-112	TP-022
					AWG8 (8.0 mm ²)	R8-6		TD-121 TD-111	TP-008
					AWG10 (5.5 mm ²)	R5.5-6	YHT-2210	-	TP-005
					AWG14 (2.0 mm ²)	R2-6		-	TP-003
					AWG16 (1.25 mm ²)			-	
		M6	2.7 to 3.0	12 mm max.	AWG14 (2.0 mm ²)	R2-6	YHT-2210	-	-

Σ-7S SERVOPACKs for Use with Single-Phase, 200-VAC Power Supplies

SERVOPACK Model: SGD7S-	Main Circuit Terminals	Screw Size	Tightening Torque [N·m]	Crimp Terminal Horizontal Width	Recommended Wire Size	Crimp Terminal Model	Crimping Tool	Die	Insulating Sleeve Model
						From J.S.T. Mfg. Co., Ltd.			
R70A, R90A, 1R6A, 2R8A, and 5R5A	Connector	-							
		M4	1.2 to 1.4	10 mm max.	AWG14 (2.0 mm ²)	R2-4	YHT-2210	-	-
120A□□□08	Terminal block	M4	1.0 to 1.2	7.7 mm max.	AWG14 (2.0 mm ²)	2-M4	YHT-2210	-	TP-003
					AWG16 (1.25 mm ²)			-	
		M4	1.2 to 1.4	10 mm max.	AWG14 (2.0 mm ²)	R2-4	YHT-2210	-	-

Σ-7S SERVOPACKs for Use with Single-Phase, 100-VAC Power Supplies

SERVOPACK Model: SGD7S-	Main Circuit Terminals	Screw Size	Tightening Torque [N·m]	Crimp Terminal Horizontal Width	Recommended Wire Size	Crimp Terminal Model	Crimping Tool	Die	Insulating Sleeve Model
						From J.S.T. Mfg. Co., Ltd.			
R70F, R90F, 2R1F, 2R8F	Connector	-							
		M4	1.2 to 1.4	10 mm max.	AWG14 (2.0 mm ²)	R2-4	YHT-2210	-	-

Σ -7W/ Σ -7C SERVOPACKs for Use with Three-Phase, 200-VAC or DC Power Supplies

SERVOPACK Model: SGD7W- or SGD7C-	Main Circuit Terminals	Screw Size	Tightening Torque [N·m]	Crimp Terminal Horizontal Width	Recommended Wire Size	Crimp Terminal Model	Crimping Tool	Die	Insulating Sleeve Model
						From J.S.T. Mfg. Co., Ltd.			
1R6A, 2R8A, 5R5A, and 7R6A	Connector	-							
		M4	1.2 to 1.4	10 mm max.	AWG14 (2.0 mm ²)	R2-4	YHT-2210	-	-

Σ -7W/ Σ -7C SERVOPACKs for Use with Single-Phase, 200-VAC Power Supplies

SERVOPACK Model: SGD7W- or SGD7C-	Main Circuit Terminals	Screw Size	Tightening Torque [N·m]	Crimp Terminal Horizontal Width	Recommended Wire Size	Crimp Terminal Model	Crimping Tool	Die	Insulating Sleeve Model
						From J.S.T. Mfg. Co., Ltd.			
1R6A, 2R8A, and 5R5A	Connector	-							
		M4	1.2 to 1.4	10 mm max.	AWG14 (2.0 mm ²)	R2-4	YHT-2210	-	-

Dynamic Brake Resistor Terminals: Σ-7S, Σ-7W, and Σ-7C SERVOPACKs

These terminals are used if you use a SERVOPACK that supports a Dynamic Brake Option and connect an External Dynamic Brake Resistor.

SERVOPACK Models		Dynamic Brake Terminals	Screw Size	Tightening Torque [N·m]	Crimp Terminal Horizontal Width	Recommended Wire Size	Crimp Terminal Model	Crimping Tool	Insulating Sleeve Model
							From J.S.T. Mfg. Co., Ltd.		From Tokyo Dip Co., Ltd.
SGD7 S-	R70A, R90A, 1R6A, 2R8A, R70F, R90F, 2R1F, and 2R8F	None				—			
	3R8A, 5R5A, 7R6A, 120A, 180A, 200A, and 330A	Connector				—			
SGD7 S-	470A and 550A	Terminal block	M4	1.0 to 1.2	9.9 mm max.	AWG12 (3.5 mm ²)	5.5-S4	YHT-2210	TP-005
						AWG14 (2.0 mm ²)	R2-4		
						AWG16 (1.25 mm ²)			
						AWG18 (0.9 mm ²)			
	590A and 780A	Terminal block	M4	1.6 to 1.8	10.6 mm max.	AWG12 (3.5 mm ²)	5.5-S4	YHT-2210	TP-005
						AWG14 (2.0 mm ²)	R2-4		
						AWG16 (1.25 mm ²)			
						AWG18 (0.9 mm ²)			
SGD7 W-	1R6A and 2R8A	None				—			
	5R5A and 7R6A	Connector				—			

Continued on next page.

9 Crimp Terminals and Insulating Sleeves

Continued from previous page.

SERVOPACK Models		Dynamic Brake Terminals	Screw Size	Tightening Torque [N·m]	Crimp Terminal Horizontal Width	Recommended Wire Size	Crimp Terminal Model	Crimping Tool	Insulating Sleeve Model
							From J.S.T. Mfg. Co., Ltd.		From Tokyo Dip Co., Ltd.
SGD7 C-	1R6A and 2R8A	None				—			
	5R5A and 7R6A	Connector				—			

9 Crimp Terminals and Insulating Sleeves

◆ Crimp Terminal Dimensional Drawing

■ Crimp Terminal Models:

R1.25-4, 2-M4, R2-4, R2-5, R2-6, 5.5-S4, R5.5-5, and R5.5-6

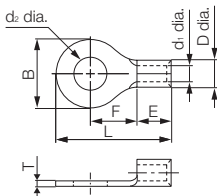

Crimp Terminal Model	Dimensions (mm)							
	d_2 dia.	B	L	F	E	D dia.	d_1 dia.	T
R1.25-4	4.3	8	15.8	7	4.8	3.4	1.7	0.8
2-M4		6.6	14.4	6.3		4.1	2.3	
R2-4		8.5	16.8	7.8				
R2-5	5.3	9.5	16.8	7.3	6.2	5.6	3.4	1.0
R2-6	6.4	12.0	21.8	11.0				
5.5-S4	4.3	7.2	15.7	5.9				
R5.5-5	5.3	9.5	19.8	8.3	6.8	5.6	3.4	1.0
R5.5-6	6.4	12.0	25.8	13.0				

- Crimp Terminal Models:
8-4NS, R8-5, R8-6, R14-5, 22-S5, R22-6, and 38-S6

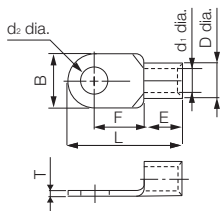

Crimp Terminal Model	Dimensions (mm)							
	d ₂ dia.	B	L	F	E	D dia.	d ₁ dia.	T
8-4NS	4.3	8.0	21.8	9.3	8.5	7.1	4.5	1.2
R8-5	5.3	12.0	23.8					
R8-6	6.4		29.8	13.3	10.5	9.0	5.8	
R14-5	5.3	12.0	30.0	12.0	12.0	11.5	7.7	1.8
22-S5			33.7	13.5				
R22-6	6.4	16.5	33.7	13.5	14.0	13.3	9.4	
38-S6		15.5	38.0	16.0				

10 SERVOPACK Overload Protection Characteristics

The overload detection level is set for hot start conditions with a SERVOPACK surrounding air temperature of 55°C.

An overload alarm (A.710 or A.720) will occur if overload operation that exceeds the overload protection characteristics shown in the following diagram (i.e., operation on the right side of the applicable line) is performed. The actual overload detection level will be the detection level of the connected SERVOPACK or Servomotor that has the lower overload protection characteristics.

In most cases, that will be the overload protection characteristics of the Servomotor.

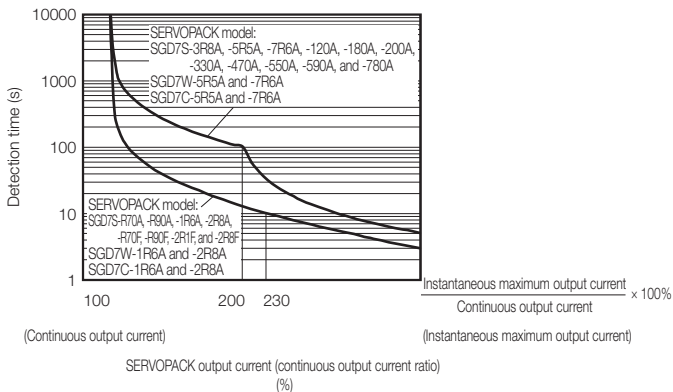

Note: The above overload protection characteristics do not mean that you can perform continuous duty operation with an output of 100% or higher.

For a Yaskawa-specified combination of SERVOPACK and Servomotor, maintain the effective torque or the effective force within the continuous duty zone of the torque-motor speed characteristics or the force-motor speed characteristics of the Servomotor. Refer to the following catalog for the torque-motor speed characteristics and force-motor speed characteristics.

📖 **Σ-7 Series (Manual No.: KAEP S800001 23)**

11 Capacitor Discharge Time

Do not touch the power supply terminals within the capacitor discharge time given in the following table after turning OFF the power supply because high voltage may still remain in the SERVOPACK.

After the CHARGE indicator goes out, use a tester to check the voltage on the DC bus line (between terminals B1/⊕ and ⊖ or ⊖2) and confirm that it is safe to proceed before starting wiring or inspection work.

Note: 1. When the parameter is set for an AC power supply input and the recommended power shutoff sequence is configured (i.e., to shut off the control power supply after shutting off the main circuit power supply), the capacitor discharge times given in the *AC Power Supply Input* column in the following table apply.

If you shut off the control power supply before you shut off the main circuit power supply, the discharge times given in the *DC Power Supply Input* column apply even if the parameter is set for an AC power supply input.

2. If a failure occurs in the SERVOPACK, the discharge times given in the *DC Power Supply Input* column may apply even if the parameter is set for an AC power supply input.

Σ-7S SERVOPACKs

SERVOPACK Model: SGD7S-	Discharge Time	
	AC Power Supply Input	DC Power Supply Input
R70A	6 min (60 ms ^{*1})	6 min
R90A	6 min (60 ms ^{*1})	6 min
1R6A	6 min (60 ms ^{*1})	6 min
2R8A	6 min (70 ms ^{*1})	6 min
3R8A	80 ms	10 min
5R5A	140 ms	15 min
7R6A	140 ms	15 min
120A (3-phase 200- VAC input)	50 ms	10 min
120A□□□008 (single-phase 200-VAC input)	60 ms	20 min
180A	60 ms	20 min
200A	60 ms	20 min
330A	70 ms	30 min
470A	90 ms ^{*2}	50 min
550A	60 ms ^{*2}	65 min
590A	70 ms ^{*2}	75 min
780A	90 ms ^{*2}	100 min
R70F	9 min (60 ms ^{*1})	— ^{*3}
R90F	9 min (60 ms ^{*1})	— ^{*3}
2R1F	9 min (60 ms ^{*1})	— ^{*3}
2R8F	9 min (90 ms ^{*1})	— ^{*3}

*1. Values in parentheses apply when an External Regenerative Resistor with a minimum allowable resistance of 40 Ω is connected.

*2. This value is for when the optional Regenerative Resistor Unit is connected.

*3. DC power supply input is not supported.

Σ -7W/ Σ -7C SERVOPACKs

SERVOPACK Model: SGD7W- or SGD7C-	Discharge Time	
	AC Power Supply Input	DC Power Supply Input
1R6A	70 ms	10 min
2R8A	140 ms	15 min
5R5A	60 ms	20 min
7R6A	60 ms	20 min

Revision History

The revision dates and numbers of the revised manuals are given at the right bottom of the back cover.

MANUAL NO. TOMP C710828 00B <1>

Revision number

Published in Japan July 2014

Date of publication

Date of Publication	Rev. No.	Section	Revised Content
May 2017	<12>	Chapter 8	Revision: Precautions for Korean Radio Waves Act
May 2017	<11>	Back cover	Revision: Address
January 2017	<10>	Chapter 6	Addition: Information on external power supply for control circuits
		Chapter 7	Addition: Information on Hazardous Substances in Revised China RoHS (Labeling of Environment-friendly Use Period)
January 2017	<9>	Back cover	Revision: Address
March 2016	<8>	Front cover, 2, 3, 5, 6, 8, 9, 10	Addition: Σ -7C SERVOPACKs
		1	Addition: Interpreting manufacturing year and month
October 2015	<7>	2, 3, 6, 8, 9, 10	Addition: SERVOPACK models for single-phase, 100-VAC input: SGD7S-R70F, -R90F, -2R1F, and -2R8F
September 2015	<6>	Back cover	Revision: Address
May 2015	<5>	Front cover, back cover	Revision: Format
February 2015	<4>	2, 3, 6, 8, 10	Addition: SERVOPACK models for single-phase, 200-VAC input: SGD7S-120A□□□008
		Front matter, 3, 8	Addition: Information on Dynamic Brake Option
October 2014	<3>	2, 5.2	Addition: Information on Option Modules

Date of Publication	Rev. No.	Section	Revised Content
September 2014	<2>	-	Japanese version only.
July 2014	<1>	All chapters	Addition: SERVOPACK models for three-phase, 200-VAC input: SGD7S-330A, -470A, -550A, -590A, and -780A
April 2014	-	-	First edition

Σ -7-Series AC Servo Drive Σ -7S, Σ -7W, and Σ -7C SERVOPACK Safety Precautions

IRUMA BUSINESS CENTER (SOLUTION CENTER)

480, Kamifujiyama, Iruma, Saitama, 358-8555, Japan
Phone: +81-4-2962-5151 Fax: +81-4-2962-6138
<http://www.yaskawa.co.jp>

YASKAWA AMERICA, INC.

2121, Norman Drive South, Waukegan, IL 60085, U.S.A.
Phone: +1-800-YASKAWA (927-5292) or +1-847-887-7000 Fax: +1-847-887-7310
<http://www.yaskawa.com>

YASKAWA ELÉTRICO DO BRASIL LTDA.

777, Avenida Piraporinha, Diadema, São Paulo, 09950-000, Brasil
Phone: +55-11-3585-1100 Fax: +55-11-3585-1187
<http://www.yaskawa.com.br>

YASKAWA EUROPE GmbH

Hauptstraße 185, 65760 Eschborn, Germany
Phone: +49-6196-569-300 Fax: +49-6196-569-398
<http://www.yaskawa.eu.com> E-mail: info@yaskawa.eu.com

YASKAWA ELECTRIC KOREA CORPORATION

35F, Three IFC, 10 Gukjegeumyung-ro, Yeongdeungpo-gu, Seoul, 07326, Korea
Phone: +82-2-784-7844 Fax: +82-2-784-8495
<http://www.yaskawa.co.kr>

YASKAWA ELECTRIC (SINGAPORE) PTE. LTD.

151, Lorong Chuan, #04-02A, New Tech Park, 556741, Singapore
Phone: +65-6282-3003 Fax: +65-6289-3003
<http://www.yaskawa.com.sg>

YASKAWA ELECTRIC (THAILAND) CO., LTD.

59, 1st-5th Floor, Flourish Building, Soi Ratchadapisek 18, Ratchadapisek Road, Huaykwang, Bangkok, 10310, Thailand
Phone: +66-2-017-0099 Fax: +66-2-017-0799
<http://www.yaskawa.co.th>

YASKAWA ELECTRIC (CHINA) CO., LTD.

22F, One Corporate Avenue, No.222, Hubin Road, Shanghai, 200021, China
Phone: +86-21-5385-2200 Fax: +86-21-5385-3299
<http://www.yaskawa.com.cn>

YASKAWA ELECTRIC (CHINA) CO., LTD. BEIJING OFFICE

Room 1011, Tower W3 Oriental Plaza, No.1, East Chang An Ave.,
Dong Cheng District, Beijing, 100738, China
Phone: +86-10-8518-4086 Fax: +86-10-8518-4082

YASKAWA ELECTRIC TAIWAN CORPORATION

12F, No. 207, Sec. 3, Beishin Rd., Shindian Dist., New Taipei City 23143, Taiwan
Phone: +886-2-8913-1333 Fax: +886-2-8913-1513 or +886-2-8913-1519
<http://www.yaskawa.com.tw>

YASKAWA

YASKAWA ELECTRIC CORPORATION

In the event that the end user of this product is to be the military and said product is to be employed in any weapons systems or the manufacture thereof, the export will fall under the relevant regulations as stipulated in the Foreign Exchange and Foreign Trade Regulations. Therefore, be sure to follow all procedures and submit all relevant documentation according to any and all rules, regulations and laws that may apply. Specifications are subject to change without notice for ongoing product modifications and improvements.
© 2014 YASKAWA ELECTRIC CORPORATION

MANUAL NO. TOMP C710828 00G <12>-0

Published in Japan May 2017

17-4-13

Original Instructions