

ACサーボドライブ 回転形サーボモータ 安全上のご注意

形式 SGM□□-□□□□□

製品を安全にお使い頂くために、本書を必ずお読みください。
また、本書をお手元に保管していただくとともに、最終的に本製品をご使用になるユーザー様のお手元に確実に届けられるよう、お取り計らい願います。

AC Servo Drive Rotary Servomotor Safety Precautions

Type SGM□□-□□□□□

To properly use the product, read this manual thoroughly and retain for easy reference, inspection, and maintenance. Ensure the end user receives this manual.

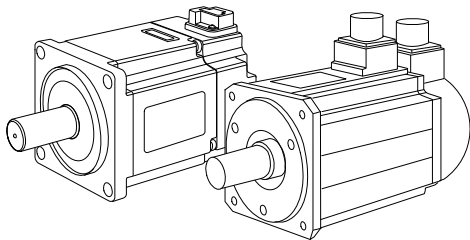

Copyright © 2014 YASKAWA ELECTRIC CORPORATION

All rights reserved. No part of this publication may be reproduced, stored in a retrieval system, or transmitted, in any form, or by any means, mechanical, electronic, photocopying, recording, or otherwise, without the prior written permission of Yaskawa. No patent liability is assumed with respect to the use of the information contained herein. Moreover, because Yaskawa is constantly striving to improve its high-quality products, the information contained in this manual is subject to change without notice. Every precaution has been taken in the preparation of this manual. Nevertheless, Yaskawa assumes no responsibility for errors or omissions. Neither is any liability assumed for damages resulting from the use of the information contained in this publication.

Before You Use the Product

◆ Product Confirmation

Please check the model number on the nameplate to confirm that you have received the correct model of Servomotor.

If you have received the wrong model or if the Servomotor is damaged in any way, please contact your Yaskawa representative.

◆ Part Names

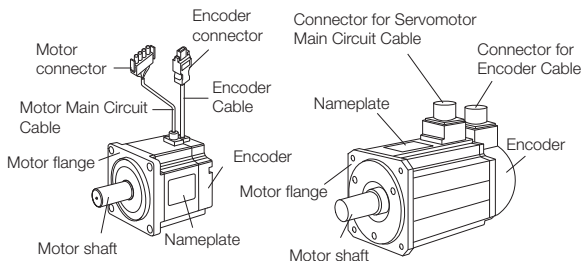

Note: The actual shape of the Servomotor depends on the series and model.

Safety Precautions

◆ Safety Information

To prevent personal injury and equipment damage in advance, the following signal words are used to indicate safety precautions in this document. The signal words are used to classify the hazards and the degree of damage or injury that may occur if a product is used incorrectly. Information marked as shown below is important for safety. Always read this information and heed the precautions that are provided.



DANGER

- Indicates precautions that, if not heeded, are likely to result in loss of life, serious injury, or fire.



WARNING

- Indicates precautions that, if not heeded, could result in loss of life, serious injury, or fire.



CAUTION

- Indicates precautions that, if not heeded, could result in relatively serious or minor injury, or in fire.

NOTICE

- Indicates precautions that, if not heeded, could result in property damage.

◆ Safety Precautions That Must Always Be Observed

■ General Precautions



DANGER

- Read and understand this manual to ensure the safe usage of the product.
- Keep this manual in a safe, convenient place so that it can be referred to whenever necessary. Make sure that it is delivered to the final user of the product.
- Do not remove covers, cables, connectors, or optional devices while power is being supplied to the SERVOPACK.
There is a risk of electric shock, operational failure of the product, or burning.



WARNING

- Connect the ground terminals on the SERVOPACK and Servomotor to ground poles according to local electrical codes. (Connect to 100 Ω or less for a SERVOPACK with a 100-VAC or 200-VAC power supply, and 10 Ω or less for a SERVOPACK with a 400-VAC power supply.)
There is a risk of electric shock or fire.
- Do not attempt to disassemble, repair, or modify the product.
There is a risk of fire or failure.
The warranty is void for the product if you disassemble, repair, or modify it.

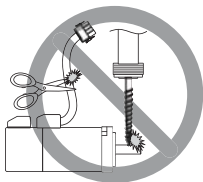



CAUTION

- The SERVOPACK heat sinks, regenerative resistors, Servomotors, and other components can be very hot while power is ON or soon after the power is turned OFF. Implement safety measures, such as installing covers, so that hands and parts such as cables do not come into contact with hot components.

There is a risk of burn injury.

- Do not damage, pull on, apply excessive force to, place heavy objects on, or pinch cables.

There is a risk of failure, damage, or electric shock.

- Do not use the product in an environment that is subject to water, corrosive gases, or flammable gases, or near flammable materials.

There is a risk of electric shock or fire.

NOTICE

- Do not attempt to use a SERVOPACK or Servomotor that is damaged or that has missing parts.
- Install external emergency stop circuits that shut OFF the power supply and stops operation immediately when an error occurs.
- Select the brake power supply for a Servomotor with a Holding Brake according to the power supply voltage and capacity required for the Servomotor model, as given in manuals and catalogs. Also confirm the input voltage to the holding brake.

- Always install a surge absorber as a protective device between the brake power supply and Servomotor.

There is a risk of damage to the Servomotor.

- The time required for a holding brake to operate depends on the types of protective devices. The time required for a holding brake to operate will also change if holding brakes are connected in parallel. Always check the time required for a holding brake to operate on the actual machine before you operate a Servomotor.

- Always use a Servomotor and SERVOPACK in one of the specified combinations.

- Do not touch a SERVOPACK or Servomotor with wet hands.

There is a risk of product failure.

■ Storage Precautions



CAUTION

- Do not place an excessive load on the product during storage. (Follow all instructions on the packages.)

There is a risk of injury or damage.

NOTICE

- Do not install or store the product in any of the following locations.
 - Locations that are subject to direct sunlight
 - Locations that are subject to ambient temperatures that exceed product specifications
 - Locations that are subject to relative humidities that exceed product specifications
 - Locations that are subject to condensation as the result of extreme changes in temperature
 - Locations that are subject to corrosive or flammable gases
 - Locations that are near flammable materials
 - Locations that are subject to dust, salts, or iron powder
 - Locations that are subject to water, oil, or chemicals
 - Locations that are subject to vibration or shock that exceeds product specifications
 - Locations that are subject to radiationIf you store or install the product in any of the above locations, the product may fail or be damaged.
- Although machined surfaces are covered with an anticorrosive coating, rust can develop due to storage conditions or the length of storage. If you store the product for more than six months, reapply an anticorrosive coating to machined surfaces, particularly the motor shaft.
- Consult with your Yaskawa representative if you have stored products for an extended period of time.

■ Transportation Precautions



CAUTION

- Transport the product in a way that is suitable to the mass of the product.
- Do not hold onto the cables or motor shaft when you move a Servomotor.
There is a risk of disconnection, damage, or injury.
- Do not use the eyebolts on a SERVOPACK or Servomotor to move the machine.
There is a risk of damage or injury.
- When you handle a SERVOPACK or Servomotor, be careful of sharp parts, such as the corners.
There is a risk of injury.
- Do not place an excessive load on the product during transportation. (Follow all instructions on the packages.)
There is a risk of injury or damage.

NOTICE

- A SERVOPACK or Servomotor is a precision device. Do not drop it or subject it to strong shock.
There is a risk of failure or damage.
- Do not subject connectors to shock.
There is a risk of faulty connections or damage.
- If disinfectants or insecticides must be used to treat packing materials such as wooden frames, plywood, or pallets, the packing materials must be treated before the product is packaged, and methods other than fumigation must be used.

Example: Heat treatment, where materials are kiln-dried to a core temperature of 56°C for 30 minutes or more.

If the electronic products, which include stand-alone products and products installed in machines, are packed with fumigated wooden materials, the electrical components may be greatly damaged by the gases or fumes resulting from the fumigation process. In particular, disinfectants containing halogen, which includes chlorine, fluorine, bromine, or iodine can contribute to the erosion of the capacitors.

- Do not overtighten the eyebolts on a SERVOPACK or Servomotor.
If you use a tool to overtighten the eyebolts, the tapped holes may be damaged.

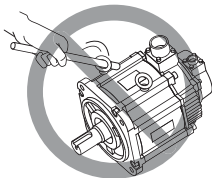

■ Installation Precautions

CAUTION

- Do not touch the key slot with your bare hands on the shaft end on a Servomotor with a Key Slot.
There is a risk of injury.
- Securely mount the Servomotor to the machine.
If the Servomotor is not mounted securely, it may come off the machine during operation.
- Install the Servomotor or SERVOPACK in a way that will support the mass given in technical documents.
- Install SERVOPACKs, Servomotors, and regenerative resistors on non-flammable materials.
Installation directly onto or near flammable materials may result in fire.

Continued on next page.



CAUTION

- Do not step on or place a heavy object on the product.
There is a risk of failure, damage, or injury.
- Do not allow any foreign matter to enter the SERVOPACK or Servomotor.
There is a risk of failure or fire.
- Implement safety measures, such as installing a cover so that the rotating part of the Servomotor cannot be touched accidentally during operation.

NOTICE

- Do not install or store the product in any of the following locations.
 - Locations that are subject to direct sunlight
 - Locations that are subject to ambient temperatures that exceed product specifications
 - Locations that are subject to relative humidities that exceed product specifications
 - Locations that are subject to condensation as the result of extreme changes in temperature
 - Locations that are subject to corrosive or flammable gases
 - Locations that are near flammable materials
 - Locations that are subject to dust, salts, or iron powder
 - Locations that are subject to water, oil, or chemicals
 - Locations that are subject to vibration or shock that exceeds product specifications
 - Locations that are subject to radiationIf you store or install the product in any of the above locations, the product may fail or be damaged.
- Use the product in an environment that is appropriate for the product specifications.
If you use the product in an environment that exceeds product specifications, the product may fail or be damaged.
- A SERVOPACK or Servomotor is a precision device. Do not drop it or subject it to strong shock.
There is a risk of failure or damage.

NOTICE

- A Servomotor is a precision device. Do not subject the output shaft or the main body of the Servomotor to strong shock.

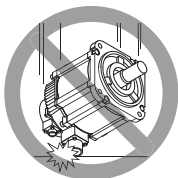
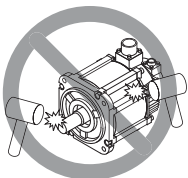

- Design the machine so that the thrust and radial loads on the motor shaft during operation do not exceed the allowable values given in the catalog.
- When you attach the key to the motor shaft, do not subject the key slot to direct shock.
- Do not allow any foreign matter to enter a SERVOPACK or a Servomotor with a Cooling Fan and do not cover the outlet from the Servomotor's cooling fan.
There is a risk of failure.
- If you use oil as the gear lubricant, always inject the specified oil before starting operation.
- You can install the Servomotor either horizontally or vertically. However, if you install a Servomotor with an Oil Seal with the output shaft facing upward, oil may enter the Servomotor depending on the operating conditions. Confirm the operating conditions sufficiently if you install a Servomotor with the output shaft facing upward. Some Servomotors with Gears have restrictions on the installation orientation. Refer to the relevant technical documents.
- If an installation orientation is specified for a Servomotor with a Gear, install the Servomotor in the specified orientation.
There is a risk of failure due to oil leakage.
- For a Servomotor with an Oil Seal, use the Servomotor with the oil seal in a lubricated condition with only splashing of oil.
If the Servomotor is used with the oil seal under the surface of the oil, oil may enter the Servomotor, possibly resulting in failure.
- The shaft opening of a Servomotor is not waterproof or oilproof. Implement measures in the machine to prevent water or cutting oil from entering the Servomotor.
There is a risk of failure.

Continued on next page.

NOTICE

- In an application where the Servomotor would be subjected to large quantities of water or oil, implement measures to protect the Servomotor from large quantities of liquid, such as installing covers to protect against water and oil.
- In an environment with high humidity or oil mist, face Servomotor lead wires and connectors downward and provide cable traps. There is a risk of failure or fire due to insulation failure or accidents from short circuits.

■ Wiring Precautions



DANGER

- Do not change any wiring while power is being supplied. There is a risk of electric shock or injury.

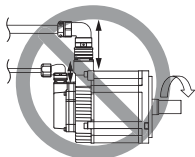

WARNING

- Wiring and inspections must be performed only by qualified engineers. There is a risk of electric shock or product failure.
- Check all wiring and power supplies carefully. Incorrect wiring or incorrect voltage application to the output circuits may cause short-circuit failures. If a short-circuit failure occurs as a result of any of these causes, the holding brake will not work. This could damage the machine or cause an accident that may result in death or injury.



CAUTION

- Observe the precautions and instructions for wiring and trial operation precisely as described in this document. Failures caused by incorrect wiring or incorrect voltage application in the brake circuit may cause the SERVOPACK to fail, damage the equipment, or cause an accident resulting in death or injury.

 **CAUTION**

- Check the wiring to be sure it has been performed correctly. Connectors and pin layouts are sometimes different for different models. Always confirm the pin layouts in technical documents for your model before operation.
There is a risk of failure or malfunction.
- Connect wires to power supply terminals and motor connection terminals securely with the specified methods and tightening torque.
Insufficient tightening may cause wires and terminal blocks to generate heat due to faulty contact, possibly resulting in fire.
- Use shielded twisted-pair cables or screened unshielded multi-twisted-pair cables for I/O Signal Cables and Encoder Cables.
- Observe the following precautions when wiring the SERVOPACK's main circuit terminals.
 - Turn ON the power supply to the SERVOPACK only after all wiring, including the main circuit terminals, has been completed.
 - If a connector is used for the main circuit terminals, remove the main circuit connector from the SERVOPACK before you wire it.
 - Insert only one wire per insertion hole in the main circuit terminals.
 - When you insert a wire, make sure that the conductor wire (e.g., whiskers) does not come into contact with adjacent wires.

NOTICE

- Whenever possible, use the Cables specified by Yaskawa. If you use any other cables, confirm the rated current and application environment of your model and use the wiring materials specified by Yaskawa or equivalent materials.
- Securely tighten cable connector screws and lock mechanisms. Insufficient tightening may result in cable connectors falling off during operation.
- Do not bundle power lines (e.g., the Main Circuit Cable) and low-current lines (e.g., the I/O Signal Cables or Encoder Cables) together or run them through the same duct. If you do not place power lines and low-current lines in separate ducts, separate them by at least 30 cm. If the cables are too close to each other, malfunctions may occur due to noise affecting the low-current lines.
- For a motor with a cooling fan, check the rotation direction of the cooling fan after you wire the fan.
- Install a battery at either the host controller or on the Encoder Cable. If you install batteries both at the host controller and on the Encoder Cable at the same time, you will create a loop circuit between the batteries, resulting in a risk of damage or burning.
- When connecting a battery, connect the polarity correctly.
There is a risk of battery rupture or encoder failure.

■ Operation Precautions

WARNING

- Before starting operation with a machine connected, change the settings of the switches and parameters to match the machine. Unexpected machine operation, failure, or personal injury may occur if operation is started before appropriate settings are made.
- Do not radically change the settings of the parameters. There is a risk of unstable operation, machine damage, or injury.
- Install limit switches or stoppers at the ends of the moving parts of the machine to prevent unexpected accidents. There is a risk of machine damage or injury.
- For trial operation, securely mount the Servomotor and disconnect it from the machine. There is a risk of injury.
- Forcing the motor to stop for overtravel is disabled when the Jog (Fn002), Origin Search (Fn003), or Easy FFT (Fn206) utility function is executed. Take necessary precautions. There is a risk of machine damage or injury.
- When an alarm occurs, the motor will coast to a stop or stop with the dynamic brake according to a setting in the SERVOPACK. The coasting distance will change with the moment of inertia of the load. Check the coasting distance during trial operation and implement suitable safety measures on the machine.
- Do not enter the machine's range of motion during operation. There is a risk of injury.
- Do not touch the moving parts of the Servomotor or machine during operation. There is a risk of injury.

CAUTION

- Do not use the holding brake built into a Servomotor to stop the Servomotor. The holding brake is designed to hold the motor shaft. It is not designed as a stopping device to ensure machine safety. Provide an appropriate stopping device on the machine to ensure safety. There is a risk of brake failure due to wear, damage to the machine, or injury.
- Before you operate a Servomotor, supply power to the holding brake to release the holding brake. Refer to the timing charts in your Servomotor manual for details.
- During trial operation, confirm that the holding brake works correctly.

Continued on next page.

CAUTION

- When overtravel occurs, the power supply to the motor is turned OFF and the brake is released. If you use the Servomotor to drive a vertical load, set the Servomotor to enter a zero-clamped state after the Servomotor stops. Also, install safety devices (such as an external brake or counterweight) to prevent the moving parts of the machine from falling.
- Always turn OFF the servo before you turn OFF the power supply. If you turn OFF the main circuit power supply or control power supply during operation before you turn OFF the servo, the Servomotor will stop as follows:
 - If you turn OFF the main circuit power supply during operation without turning OFF the servo, the Servomotor will stop abruptly with the dynamic brake.
 - If you turn OFF the control power supply without turning OFF the servo, the stopping method that is used by the Servomotor depends on the model of the SERVOPACK. For details, refer to the manual for the SERVOPACK.

NOTICE

- Always measure the vibration of the Servomotor with the Servomotor mounted to the machine and confirm that the vibration is within the allowable value.
If the vibration is too large, the Servomotor will be damaged quickly and bolts may become loose.
- When you adjust the gain during system commissioning, use a measuring instrument to monitor the torque waveform and speed waveform and confirm that there is no vibration.
If a high gain causes vibration, the Servomotor will be damaged quickly.
- An alarm or warning may occur if communications are performed with the host controller while the SigmaWin+ or Digital Operator is operating.
If an alarm or warning occurs, it may interrupt the current process and stop the system.

■ Maintenance and Inspection Precautions

DANGER

- Do not change any wiring while power is being supplied.
There is a risk of electric shock or injury.

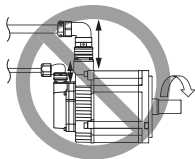

WARNING

- Wiring and inspections must be performed only by qualified engineers
There is a risk of electric shock or product failure.
- If you replace a Servomotor with a Holding Brake, secure the machine before you replace the Servomotor.
There is a risk of injury or equipment damage if the equipment falls.

CAUTION

- Wait for six minutes after turning OFF the power supply and then make sure that the CHARGE indicator is not lit before starting wiring or inspection work. Do not touch the power supply terminals while the CHARGE lamp is lit after turning OFF the power supply because high voltage may still remain in the SERVOPACK.
There is a risk of electric shock.
- Replace the Battery according to the correct procedure.
If you remove the Battery or disconnect the Encoder Cable while the control power supply to the SERVOPACK is OFF, the absolute encoder data will be lost and position deviation may occur.

■ Troubleshooting Precautions

WARNING

- The product may suddenly start to operate when the power supply is recovered after a momentary power interruption. Design the machine to ensure human safety when operation restarts.
There is a risk of injury.



CAUTION

- When an alarm occurs, remove the cause of the alarm and ensure safety. Then reset the alarm or turn the power supply OFF and ON again to restart operation.
There is a risk of injury or machine damage.
- If the Servo ON signal is input to the SERVOPACK and an alarm is reset, the Servomotor may suddenly restart operation. Confirm that the servo is OFF and ensure safety before you reset an alarm.
There is a risk of injury or machine damage.
- The holding brake on a Servomotor will not ensure safety if there is the possibility that an external force (including gravity) may move the current position and create a hazardous situation when power is interrupted or an error occurs. If an external force may cause movement, install an external braking mechanism that ensures safety.

■ Disposal Precautions

- When disposing of the product, treat it as ordinary industrial waste. However, local ordinances and national laws must be observed. Implement all labeling and warnings as a final product as required.

■ General Precautions

- Figures provided in this document are typical examples or conceptual representations. There may be differences between them and actual wiring, circuits, and products.
- The products shown in illustrations in this document are sometimes shown without covers or protective guards. Always replace all covers and protective guards before you use the product.
- If you need a new copy of this document because it has been lost or damaged, contact your nearest Yaskawa representative or one of the offices listed on the back of this document.
- This document is subject to change without notice for product improvements, specifications changes, and improvements to the manual itself.
We will update the document number of the document and issue revisions when changes are made.
- Any and all quality guarantees provided by Yaskawa are null and void if the customer modifies the product in any way. Yaskawa disavows any responsibility for damages or losses that are caused by modified products.

Warranty

◆ Details of Warranty

■ Warranty Period

The warranty period for a product that was purchased (hereinafter called the “delivered product”) is one year from the time of delivery to the location specified by the customer or 18 months from the time of shipment from the Yaskawa factory, whichever is sooner.

■ Warranty Scope

Yaskawa shall replace or repair a defective product free of charge if a defect attributable to Yaskawa occurs during the above warranty period.

This warranty does not cover defects caused by the delivered product reaching the end of its service life and replacement of parts that require replacement or that have a limited service life.

This warranty does not cover failures that result from any of the following causes.

- Improper handling, abuse, or use in unsuitable conditions or in environments not described in product catalogs or manuals, or in any separately agreed-upon specifications
- Causes not attributable to the delivered product itself
- Modifications or repairs not performed by Yaskawa
- Use of the delivered product in a manner in which it was not originally intended
- Causes that were not foreseeable with the scientific and technological understanding at the time of shipment from Yaskawa
- Events for which Yaskawa is not responsible, such as natural or human-made disasters

◆ Limitations of Liability

- Yaskawa shall in no event be responsible for any damage or loss of opportunity to the customer that arises due to failure of the delivered product.
- Yaskawa shall not be responsible for any programs (including parameter settings) or the results of program execution of the programs provided by the user or by a third party for use with programmable Yaskawa products.
- The information described in product catalogs or manuals is provided for the purpose of the customer purchasing the appropriate product for the intended application. The use thereof does not guarantee that there are no infringements of intellectual property rights or other proprietary rights of Yaskawa or third parties, nor does it construe a license.
- Yaskawa shall not be responsible for any damage arising from infringements of intellectual property rights or other proprietary rights of third parties as a result of using the information described in catalogs or manuals.

◆ Suitability for Use

- It is the customer's responsibility to confirm conformity with any standards, codes, or regulations that apply if the Yaskawa product is used in combination with any other products.
- The customer must confirm that the Yaskawa product is suitable for the systems, machines, and equipment used by the customer.
- Consult with Yaskawa to determine whether use in the following applications is acceptable. If use in the application is acceptable, use the product with extra allowance in ratings and specifications, and provide safety measures to minimize hazards in the event of failure.
 - Outdoor use, use involving potential chemical contamination or electrical interference, or use in conditions or environments not described in product catalogs or manuals
 - Nuclear energy control systems, combustion systems, railroad systems, aviation systems, vehicle systems, medical equipment, amusement machines, and installations subject to separate industry or government regulations
 - Systems, machines, and equipment that may present a risk to life or property
 - Systems that require a high degree of reliability, such as systems that supply gas, water, or electricity, or systems that operate continuously 24 hours a day
 - Other systems that require a similar high degree of safety
- Never use the product for an application involving serious risk to life or property without first ensuring that the system is designed to secure the required level of safety with risk warnings and redundancy, and that the Yaskawa product is properly rated and installed.
- The circuit examples and other application examples described in product catalogs and manuals are for reference. Check the functionality and safety of the actual devices and equipment to be used before using the product.
- Read and understand all use prohibitions and precautions, and operate the Yaskawa product correctly to prevent accidental harm to third parties.

◆ Specifications Change

The names, specifications, appearance, and accessories of products in product catalogs and manuals may be changed at any time based on improvements and other reasons. The next editions of the revised catalogs or manuals will be published with updated code numbers. Consult with your Yaskawa representative to confirm the actual specifications before purchasing a product.

1 Product Handling Precautions

Handling Servomotors

Observe the following precautions when you handle Servomotors.

- Do not subject the Servomotor to shock.

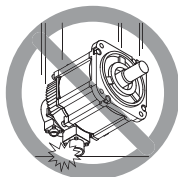
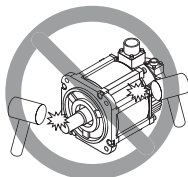

- Do not hold onto the motor shaft or cables when you move the Servomotor.

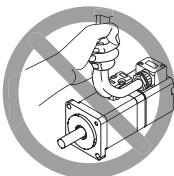
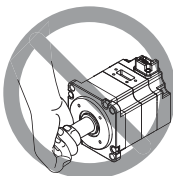

Servomotor Installation Environment

Install the Servomotor in the following environments.

If you use a Servomotor in an inappropriate environment, the Servomotor or encoder may be damaged.

- Confirm the ambient operating temperature for your Servomotor in the product specifications in the Servomotor catalog or other product documentation.

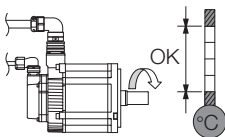

1 Product Handling Precautions

- The surrounding air humidity is 20% to 80% relative humidity (with no condensation).

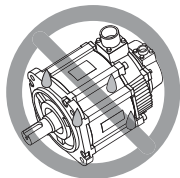

- The vibration resistance (vibration acceleration rate) of the Servomotor is based on the flange surface of the Servomotor. The vibration resistance depends on the model. Confirm the vibration resistance in the product specifications in the product catalog or other product documentation.
- If you reduce the thickness of the mounting section (i.e., the heat sink) of the Servomotor, the rigidity will be reduced, which could increase vibration.

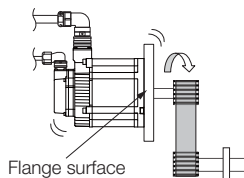

- Do not subject a Servomotor to shock. The shock resistance of a Servomotor (impact acceleration rate \times the number of impacts) is $490 \text{ m/s}^2 \times 2$ impacts at the flange surface of the Servomotor.

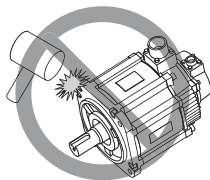

- Wire the Servomotor so that force is not applied to the cables and connectors.

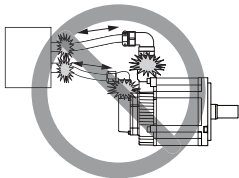

- An absolute encoder has a magnetic sensor attached to it. Do not install equipment that exerts a strong magnetic force near the Servomotor (i.e., a magnetic force of 0.01 tesla or 100 gauss or higher when measured at the encoder cover).

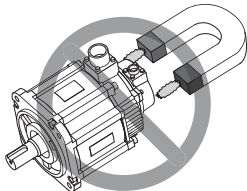

Protective Structure of Servomotors

The protection class of a Servomotor depends on the model and option specifications of the Servomotor.

Confirm the protection class of your Servomotor in the Servomotor manual or catalog, or on Yaskawa's product and technical information website (<http://www.emechatronics.com/>).

Observe the following precautions in reference to the protective structure (protection class).

- The protection class indicates the degree of protection against the entry of water.
- If you use oils, coolants, or other liquids with high permeability, protect the Servomotor with a cover or other device so that the liquid does not come into direct contact with the Servomotor.
- The protective structure of the Servomotor does not apply to the shaft opening. Also, you must use the specified connectors for the Servomotor.

1 Product Handling Precautions

- The protective structure does not apply to the connectors (shown below with dotted circle) on Servomotors that have cables attached.

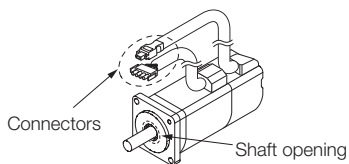
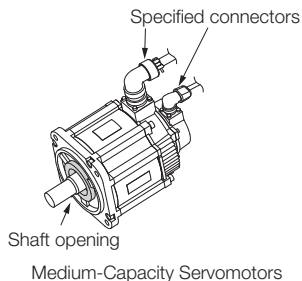

Small-Capacity Servomotors with Cables Attached

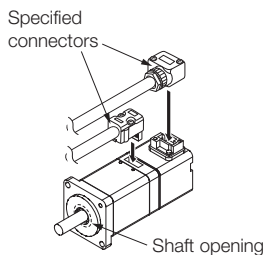

Small-Capacity Servomotors without Cables

Servomotor Heat Dissipation

The heat generated by a Servomotor dissipates through the motor flange to the motor mounting (the heat sink). Before you mount a Servomotor, confirm the appropriate heat sink dimensions for your Servomotor model in the Servomotor manual or catalog, or on Yaskawa's product and technical information website (<http://www.emechatronics.com/>).

If the application environment makes it difficult to provide an appropriate size of heat sink, contact your Yaskawa representative. Do not place packing or any other insulating material between the Servomotor and heat sink. Doing so will cause the motor temperature to increase, affect resistance to noise, and may cause motor failure.

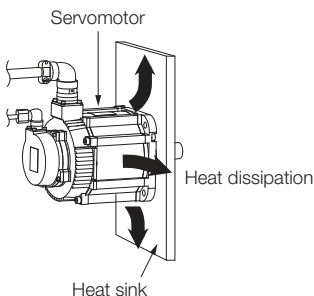

Handling Cables

Observe the following precautions when you connect the cables.

- The cables must be secured in place.
- Observe the minimum bending radii given in the following table and perform wiring so that force is not applied to the cables.

Cable Diameter	Minimum Bending Radius (R)
Less than 8 mm	15 mm min.
8 mm	20 mm min.
Over 8 mm	3 times the cable's outer diameter min.

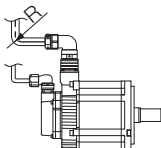

1 Product Handling Precautions

- The cables are not designed to be movable.
- Use the cables so that they are not repeatedly bent.

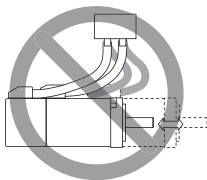

- If you secure the cables with cable ties, protect the cables with cushioning material.

Cushioning material

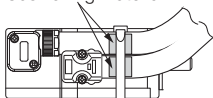

- When you connect the connectors to the Servomotor, connect the Servomotor Main Circuit Cable connector first (① in the following figure) and then connect the Encoder Cable connector (② in the following figure).

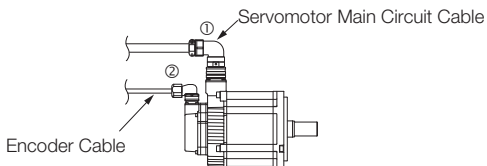

- Always use the connectors specified by Yaskawa and insert them correctly.

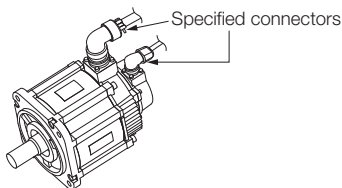

Connecting the Servomotor and Machine

◆ Using a Coupling

- Use the key that is provided with the Servomotor or a key of the size specified in the manual.
- When you attach the key to the motor shaft, do not subject the key slot to direct shock.

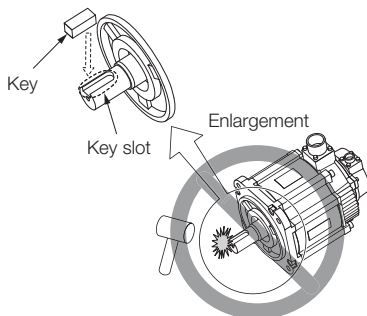

- When you attach the coupling, do not subject the shaft to shock. When you attach the load, do not exceed the allowable value of the thrust load or radial load specified in the manual or catalog.

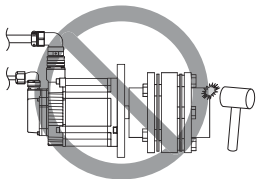

- Although the tolerance for centering the coupling depends on the speed of the motor and the type of the coupling, center the coupling within 0.03 mm. Also refer to the coupling catalog for manufacturer requirements. Even within this range, make adjustments to increase centering accuracy as much as possible.
- If the coupling makes any abnormal noise, center the shafts again until the noise is eliminated.
- Use a flexible coupling that is designed for Servomotors. We recommend that you use a double-spring coupling, which provides some tolerance in eccentricity and deflection angle.

1 Product Handling Precautions

- Select a suitable size of coupling for the operating conditions. A coupling that is too large or too small may cause damage.

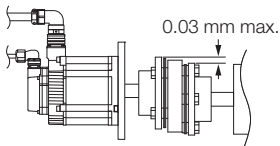

- Rotate both shafts when you center the coupling.
- We recommend that you use a dial gauge to check the accuracy of centering, but if using one is not possible, slide the coupling along both shafts and make adjustments so that it does not catch.

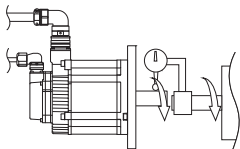

◆ Using a Belt

Select a belt that is suitable for the allowable radial load and output of the Servomotor.

When the Servomotor accelerates or decelerates, the reaction force from the acceleration/deceleration torque adds tension to the initial belt tension. Consider this when you select a belt.

- When you attach the belt, adjust the belt tension so that the allowable radial load given in the manual or catalog is not exceeded. For details, refer to the catalog of the belt manufacturer.

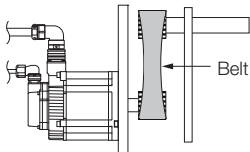

- Measure the belt tension at 45° intervals of the shafts. Turn the shafts and take measurements with a belt tension meter at each point.

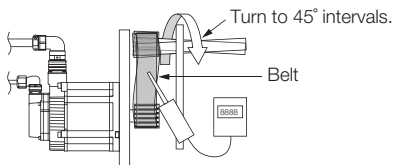

Servomotors with Oil Seals

If the Servomotor is used where the shaft opening is subject to oil mist, use a Servomotor with an Oil Seal. If the Servomotor is used where the shaft opening is not subject to oil mist, use a standard Servomotor.

The operating conditions for a Servomotor with an Oil Seal are given below.

Note: The oil seal is a single-lip, spring-loaded oil seal made of nitrile rubber (NBR).

Check the type of oil to be used with the oil seal and make sure that it is suitable.

- Use the oil seal in a lubricated condition with only splashing of oil.

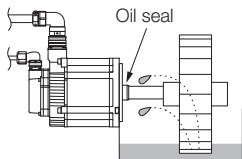

- Do not use the Servomotor where the oil seal would be below the oil surface. Oil will enter the Servomotor, which may damage the Servomotor.

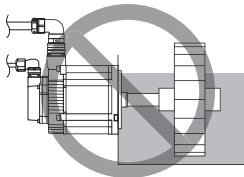

Using a Holding Brake

The holding brake is designed to hold the motor in place. Do not use it to stop the motor. If you use the holding brake to stop the motor, the holding brake or encoder may be damaged. Before you operate a Servomotor, supply power to the holding brake to release the holding brake. Refer to the timing charts in the manual for details.

- Two different power supply voltages are available for the holding brake: 24 VDC and 90 VDC.
Select the brake power supply according to the power supply voltage and capacity required for the Servomotor model, as given in the manual and product catalog.
Also confirm the input voltage to the holding brake.
- Always install a surge absorber in a protective circuit between the brake power supply and Servomotor. The time required for a holding brake to operate depends on the types of protective circuits.
Always check the time required for a holding brake to operate on the actual machine before you operate a Servomotor.

A: Brake power supply

B: Protective circuit

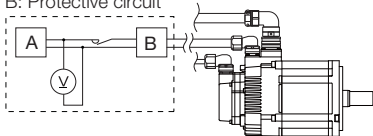

Conditions Often Misidentified as Failures

◆ Heating of Servomotors with Holding Brakes

The following condition does not indicate a failure in the Servomotor. Even if the servo is OFF, the power supply to the holding brake that releases the holding brake will cause the Servomotor to heat.

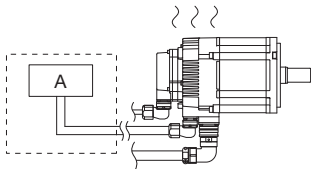

A: Brake power supply

◆ Play of the Output Shaft for Servomotors with Holding Brakes

The following condition does not indicate a failure in the Servomotor. There is backlash in the holding brake even when power is not being supplied to the holding brake. This results in a certain amount of rotational play in the motor output shaft.

Amount of play: 1.5° max. (initial value)

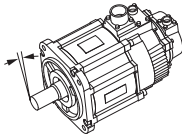

◆ Braking Noise from Servomotors with Holding Brakes

The following condition does not indicate a failure in the Servomotor.

The brake's rotating disk will cause some scratching noise during acceleration, stopping, and low-speed operation.

2 Maintenance and Inspection

◆ Periodic Inspections

The following table gives the periodic inspection items for a Servomotor. The inspection periods given in the table are guidelines. Determine the optimum inspection periods based on the application conditions and environment.



CAUTION

- Before you perform any maintenance or inspection work, turn OFF the power supply, confirm that the CHARGE indicator on the front of the SERVOPACK has gone out, and then use a tester to check the voltage between the positive and negative terminals on the SERVOPACK. Start inspection work only after you have confirmed that the main circuit voltage has dropped.

If there is any main circuit voltage left, the risk of electric shock still exists. Do not touch the Servomotor or any wiring.

- All inspection and maintenance work must be performed only by qualified engineers.
There is a risk of electric shock or injury.
- Contact your Yaskawa representative for help with failures, repairs, or part replacement.

Item	Inspection Period	Basic Inspection and Maintenance Procedure	Remarks
Check the coupling between the Servomotor and the machine.	Before starting operation	<ul style="list-style-type: none"> • Make sure that there are no loose mounting screws between the Servomotor and machine. • Make sure that there is no looseness in the coupling between the Servomotor and machine. • Make sure that there is no misalignment. 	—
Check for vibration and noise.	Daily	Inspect by touching and by listening.	There should be no more vibration or noise than normal.
Exterior	Check for dirt and grime.	Wipe off the dirt and grime with a cloth or pressurized air.	—

Continued on next page.

Continued from previous page.

Item	Inspection Period	Basic Inspection and Maintenance Procedure	Remarks
Measure the insulation resistance.	At least once a year	Disconnect the Servomotor from the SERVOPACK and measure the insulation resistance at 500 V with an insulation resistance meter. (Measurement method: Measure the resistance between phase U, V, or W on the Servomotor's power line and FG.) The insulation is normal if the resistance is 10 M Ω or higher.	If the resistance is less than 10 M Ω , contact your Yaskawa representative.
Replace the oil seal.	At least once every 5,000 hours	Contact your Yaskawa representative.	This inspection applies only to Servomotors with Oil Seals.
Overhaul	At least once every 5 years or every 20,000 hours	Contact your Yaskawa representative.	-

◆ Standard Service Life of Product

The following table gives the standard service lives of the parts of the Servomotor. Contact your Yaskawa representative using the following table as a guide. After an examination of the part in question, we will determine whether the part should be replaced. Even if the service life of a part has not expired, replacement may be required if abnormalities occur. The standard service lives in the table are only for reference. The actual service lives will depend on the application conditions and environment.

Part	Standard Service Life	Remarks
Bearings	20,000 hours	The service life is affected by operating conditions. Check for abnormal sounds and vibration during inspections.
Oil Seals	5,000 hours	The service life is affected by operating conditions. Check for oil leaks during inspections.
Brakes	20,000 hours	The service life is affected by operating conditions. Check for abnormal sounds and vibration during inspections. Confirm that the brake is released when power is supplied and check for any changes in the operating time of the brake.

Revision History

The revision dates and numbers of the revised manuals are given at the bottom of the back cover.

MANUAL NO. TOBP C230260 00A <1>

Revision number

Published in Japan August 2014

Date of publication

Date of Publication	Rev. No.	Section	Revised Content
May 2017	<6>	Back cover	Revision: Address
December 2016	<5>	Back cover	Revision: Address
September 2015	<4>	Back cover	Revision: Address
April 2015	<3>	Front cover, back cover	Revision: Format
October 2014	<2>	Back cover	Revision: Address
August 2014	<1>	–	Japanese version only.
February 2014	–	–	First edition

AC Servo Drive

Rotary Servomotor

Safety Precautions

IRUMA BUSINESS CENTER (SOLUTION CENTER)

480, Kamifujiyama, Iruma, Saitama, 358-8555, Japan
Phone: +81-4-2962-5151 Fax: +81-4-2962-6138
<http://www.yaskawa.co.jp>

YASKAWA AMERICA, INC.

2121, Norman Drive South, Waukegan, IL 60085, U.S.A.
Phone: +1-800-YASKAWA (927-5292) or +1-847-887-7000 Fax: +1-847-887-7310
<http://www.yaskawa.com>

YASKAWA ELÉTRICO DO BRASIL LTDA.

777, Avenida Piraporinha, Diadema, São Paulo, 09950-000, Brasil
Phone: +55-11-3585-1100 Fax: +55-11-3585-1187
<http://www.yaskawa.com.br>

YASKAWA EUROPE GmbH

Hauptstraße 185, 65760 Eschborn, Germany
Phone: +49-6196-569-300 Fax: +49-6196-569-398
<http://www.yaskawa.eu.com> E-mail: info@yaskawa.eu.com

YASKAWA ELECTRIC KOREA CORPORATION

35F, Three IFC, 10 Gukjegeumyung-ro, Yeongdeungpo-gu, Seoul, 07326, Korea
Phone: +82-2-784-7844 Fax: +82-2-784-8495
<http://www.yaskawa.co.kr>

YASKAWA ELECTRIC (SINGAPORE) PTE. LTD.

151, Lorong Chuan, #04-02A, New Tech Park, 556741, Singapore
Phone: +65-6282-3003 Fax: +65-6289-3003
<http://www.yaskawa.com.sg>

YASKAWA ELECTRIC (THAILAND) CO., LTD.

59, 1st-5th Floor, Flourish Building, Soi Ratchadapisek 18, Ratchadapisek Road, Huaykwang, Bangkok, 10310, Thailand
Phone: +66-2-017-0099 Fax: +66-2-017-0799
<http://www.yaskawa.co.th>

YASKAWA ELECTRIC (CHINA) CO., LTD.

22F, One Corporate Avenue, No.222, Hubin Road, Shanghai, 200021, China
Phone: +86-21-5385-2200 Fax: +86-21-5385-3299
<http://www.yaskawa.com.cn>

YASKAWA ELECTRIC (CHINA) CO., LTD. BEIJING OFFICE

Room 1011, Tower W3 Oriental Plaza, No.1, East Chang An Ave.,
Dong Cheng District, Beijing, 100738, China
Phone: +86-10-8518-4086 Fax: +86-10-8518-4082

YASKAWA ELECTRIC TAIWAN CORPORATION

12F, No. 207, Sec. 3, Beishin Rd., Shindian Dist., New Taipei City 23143, Taiwan
Phone: +886-2-8913-1333 Fax: +886-2-8913-1513 or +886-2-8913-1519
<http://www.yaskawa.com.tw>

YASKAWA

YASKAWA ELECTRIC CORPORATION

In the event that the end user of this product is to be the military and said product is to be employed in any weapons systems or the manufacture thereof, the export will fall under the relevant regulations as stipulated in the Foreign Exchange and Foreign Trade Regulations. Therefore, be sure to follow all procedures and submit all relevant documentation according to any and all rules, regulations and laws that may apply. Specifications are subject to change without notice for ongoing product modifications and improvements.
© 2014 YASKAWA ELECTRIC CORPORATION

MANUAL NO. TOBP C230260 00A <6>-0

Published in Japan May 2017

17-4-13

Original Instructions